



KERN & Sohn GmbH

Ziegelei 1
72336 Balingen-Frommern
Germany

www.kern-sohn.com

+0049-[0]7433-9933-0

+0049-[0]7433-9933-149

info@kern-sohn.com

Operating instructions

Precision scales

KERN PDS, PDT

Type TPDS-A, TPDT-A

Version 1.1

2024-12

GB



TPDS-A_TPDT-A-BA-e-2411



KERN PDS, PDT

Version 1.1 2024-12

Operating instructions

Precision scales

Contents

1	Technical data	5
2	Declaration of Conformity	10
3	Device overview	11
3.1	Components	11
3.2	Operating elements	13
4	Basic information (general)	16
4.1	Intended use	16
4.2	Improper use	16
4.3	Guarantee	16
4.4	Test equipment monitoring	17
5	Basic safety instructions	17
5.1	Observe the notes in the operating instructions	17
5.2	Staff training	17
6	Transport and storage	17
6.1	Control on takeover	17
6.2	Packaging/return transport	17
7	Unpacking, installation and commissioning	18
7.1	Installation site, place of use	18
7.2	Unpacking and checking	19
7.3	Assembly, installation and levelling	19
7.4	Mains connection	21
7.5	Connection of peripheral devices	22
7.6	Initial commissioning	22
8	Adjustment	23
8.1	External adjustment	24
8.2	External adjustment with user-defined adjustment weight	26

8.3	Internal adjustment.....	29
8.4	Automatic internal calibration (isoCAL)	30
9	Basic operation	32
9.1	General instructions for operating with draft shield	32
9.2	Switch on.....	32
9.3	Standby mode	33
9.4	Zeros	33
9.5	Taring.....	34
10	Applications.....	36
10.1	Selection of a weighing application	36
10.2	Simple weighing.....	37
10.3	Counting	42
10.4	Percentage weighing	44
10.5	Net total	46
10.6	Dynamic weighing.....	48
10.7	Calculation	51
10.8	Density determination	53
10.9	Statistics function	58
10.10	Peak value function	61
10.11	Tolerance weighing.....	63
10.12	Totalise	65
11	Menu.....	67
11.1	Navigation in the menu	67
11.2	Main menu	67
11.3	Setup menu.....	69
11.4	Device settings.....	72
11.5	Data output settings	73
11.6	Input menu	74
12	Communication with peripheral devices	75
12.1	RS232 / RS485 interface	75
12.2	USB-C connection	75
12.3	Connecting the printer to a scale	75
13	Maintenance, servicing, disposal	76
13.1	Cleaning.....	76

13.2	Maintenance, servicing	76
13.3	Waste disposal.....	76
14	Small breakdown service	77
15	Error messages	78

1 Technical data

KERN	PDS 300-3	PDS 600-3	PDS 1000-3
Item number / type	TPDS 320-3-A	TPDS 620-3-A	TPDS 1020-3-A
Readability (d)	0,001 g	0,001 g	0,001 g
Weighing range (max)	320 g	620 g	1020 g
Reproducibility	0,003 g	0,003 g	0,004 g
Linearity	0,003 g	0,003 g	0,005 g
Settling time (typical)	3 s	3 s	4 s
Smallest part weight for piece counting under laboratory conditions*	10 mg	10 mg	10 mg
Smallest part weight for piece counting under normal conditions**	100 mg	100 mg	100 mg
Recommended calibration weight, not included, (class)	200 g (E2)	500 g (E2)	1 kg (E2)
Possible adjustment points	200 g / 300 g	500 g / 600 g	500 g / 1 kg
Warm-up time	2 h	4 h	8 h
Weighing units	g, kg, gn, dwt, tl (Taiwan), ozt, ct, lb, oz, FFA		
Air humidity	max. 80% rel. (non-condensing)		
Permissible ambient temperature	+ 15 °C ... + 25 °C		
Input voltage device	12 V, 2 A		
Input voltage power supply unit	100 V - 240V AC 50 / 60Hz		
Housing dimensions (fully assembled)	207 x 318 x 360 (W x D x H) [mm]		
Weighing plate, stainless steel	Ø 115 mm		
Net weight	6 kg		
Interfaces	RS232 / RS485, USB-C		

CORE	PDS 2000-2	PDS 4000-2	PDS 6000-2
Item number / type	TPDS 2200-2-A	TPDS 4200-2-A	TPDS 6200-2-A
Readability (d)	0,001 g	0,01 g	0,01 g
Weighing range (max)	2200 g	4200 g	6200 g
Reproducibility	0,03 g	0,03 g	0,03 g
Linearity	0,03 g	0,03 g	0,03 g
Settling time (typical)	2 s	3 s	3 s
Smallest part weight for piece counting under laboratory conditions*	100 mg	100 mg	100 mg
Smallest part weight for piece counting under normal conditions**	1 g	1 g	1 g
Recommended calibration weight, not included, (class)	2 kg (E2)	4 kg (E2)	5 kg (E2)
Possible adjustment points	1 kg / 2 kg	2 kg / 4 kg	5 kg / 6 kg
Warm-up time	2 h	4 h	4 h
Weighing units	g, kg, gn, dwt, tl (Taiwan), ozt, ct, lb, oz, FFA		
Air humidity	max. 80% rel. (non-condensing)		
Permissible ambient temperature	+ 15 °C ... + 25 °C		
Input voltage Device	12 V, 2 A		
Input voltage power supply unit	100 V - 240V AC 50 / 60Hz		
Housing dimensions (fully assembled)	207 x 318 x 110 (W x D x H) [mm]		
Weighing plate, stainless steel	185 x 185 (W x D) [mm]		
Net weight	3.6 kg		
Interfaces	RS232 / RS485, USB-C		

CORE	PDS 10K-5
Item number / type	TPDS 10200-2-A
Readability (d)	0,01 g
Weighing range (max)	10200 g
Reproducibility	0,03 g
Linearity	0,03 g
Settling time (typical)	5 s
Smallest part weight for piece counting under laboratory conditions*	100 mg
Smallest part weight for piece counting under normal conditions**	1 g
Recommended calibration weight, not included, (class)	5 kg (E2)
Possible adjustment points	1 kg / 5 kg
Warm-up time	8 h
Weighing units	g, kg, gn, dwt, tl (Taiwan), ozt, ct, lb, oz, FFA
Air humidity	max. 80% rel. (non-condensing)
Permissible ambient temperature	+ 15 °C ... + 25 °C
Input voltage Device	12 V, 2 A
Input voltage power supply unit	100 V - 240V AC 50 / 60Hz
Housing dimensions (fully assembled)	207 x 318 x 110 (W x D x H) [mm]
Weighing plate, stainless steel	185 x 185 (W x D) [mm]
Net weight	5 kg
Interfaces	RS232 / RS485, USB-C

CORE	PDT 300-3	PDT 600-3	PDT 1000-3
Item number / type	TPDT 320-3-A	TPDT 620-3-A	TPDT 1020-3-A
Readability (d)	0,001 g	0,001 g	0,001 g
Weighing range (max)	320 g	620 g	1020 g
Reproducibility	0,003 g	0,003 g	0,004 g
Linearity	0,003 g	0,003 g	0,005 g
Settling time (typical)	3 s		4 s
Smallest part weight for piece counting under laboratory conditions*	10 mg	10 mg	10 mg
Smallest part weight for piece counting under normal conditions**	100 mg	100 mg	100 mg
Recommended calibration weight, not included, (class)	200 g (E2)	500 g (E2)	1 kg (E2)
Possible adjustment points	200 g / 300 g	500 g / 600 g	500 g / 1 kg
Warm-up time	2 h	4h	8 h
Weighing units	g, kg, gn, dwt, tl (Taiwan), ozt, ct, lb, oz, FFA		
Air humidity	max. 80% rel. (non-condensing)		
Permissible ambient temperature	+ 15 °C ... + 25 °C		
Input voltage Device	12 V, 2 A		
Input voltage power supply unit	100 V - 240V AC 50 / 60Hz		
Housing dimensions (fully assembled)	207 x 318 x 360 (W x D x H) [mm]		
Weighing plate, stainless steel	Ø 115 mm		
Net weight	6 kg		
Interfaces	RS232 / RS485, USB-C		

CORE	PDT 2000-2	PDT 4000-2	PDT 6000-2
Item number / type	TPDT 2200-2-A	TPDT 4200-2-A	TPDT 6200-2-A
Readability (d)	0,01 g	0,01 g	0,01 g
Weighing range (max)	2200 g	4200 g	6200 g
Reproducibility	0,03 g	0,03 g	0,03 g
Linearity	0,03 g	0,03 g	0,03 g
Settling time (typical)	2 s	3 s	3 s
Smallest part weight for piece counting under laboratory conditions*	100 mg	100 mg	100 mg
Smallest part weight for piece counting under normal conditions**	1 g	1 g	1 g
Recommended calibration weight, not included, (class)	2 kg (E2)	4 kg (E2)	5 kg (E2)
Possible adjustment points	1 kg / 2 kg	2 kg / 4 kg	5 kg / 6 kg
Warm-up time	4 h	4 h	4 h
Weighing units	g, kg, gn, dwt, tl (Taiwan), ozt, ct, lb, oz, FFA		
Air humidity	max. 80% rel. (non-condensing)		
Permissible ambient temperature	+ 15 °C ... + 25 °C		
Input voltage device	12 V, 2 A		
Input voltage power supply unit	100 V - 240V AC 50 / 60Hz		
Housing dimensions (fully assembled)	207 x 318 x 110 (W x D x H) [mm]		
Weighing plate, stainless steel	185 x 185 (W x D) [mm]		
Net weight	3.6 kg		
Interfaces	RS232 / RS485, USB-C		

*** Smallest part weight for piece counting - under laboratory conditions:**

- There are ideal environmental conditions for high-resolution counting
- The counting parts have no dispersion

**** Smallest part weight for piece counting - under normal conditions:**

- Unsettled ambient conditions prevail (wind draught, vibrations)
- The counting parts scatter

2 Declaration of Conformity

You can find the current EC/EU Declaration of Conformity online at

www.kern-sohn.com/ce

3 Device overview

3.1 Components

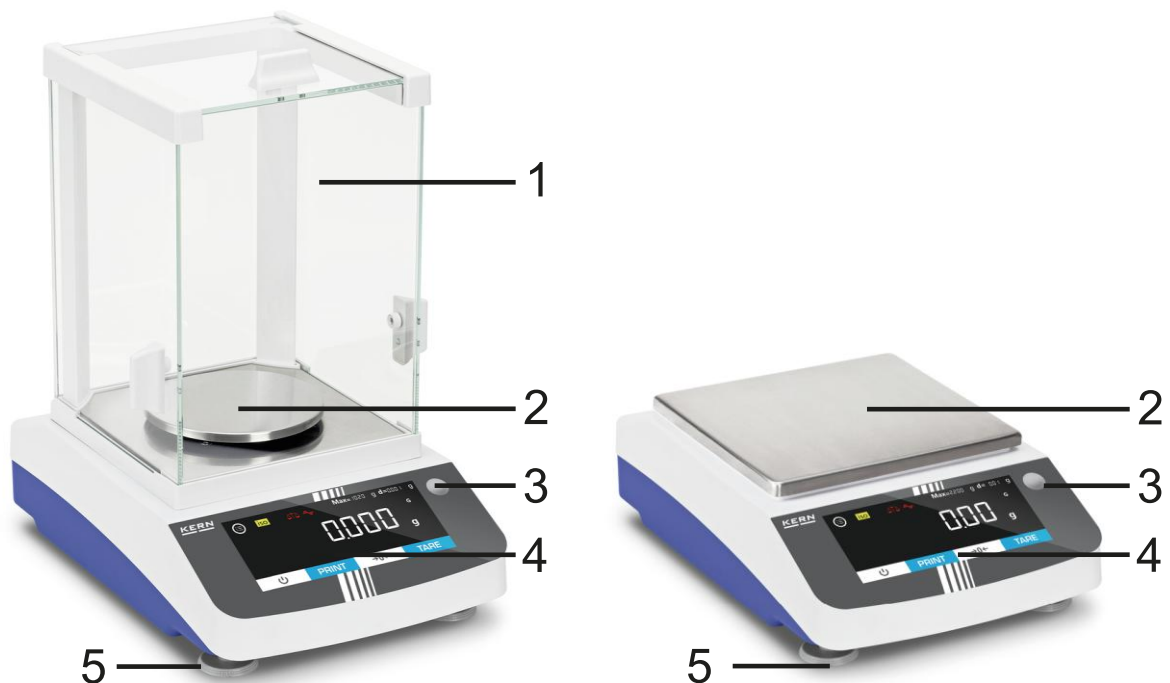

Pos.	Designation
1	Windbreak
2	Weighing plate
3	Bubble level
4	Display with buttons (touchscreen)
5	Levelling feet

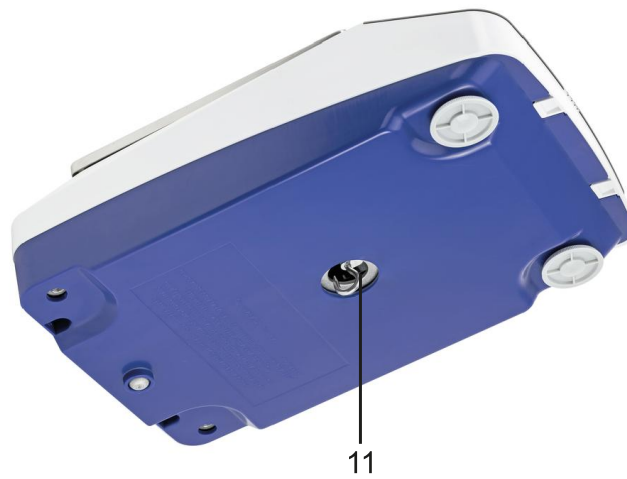



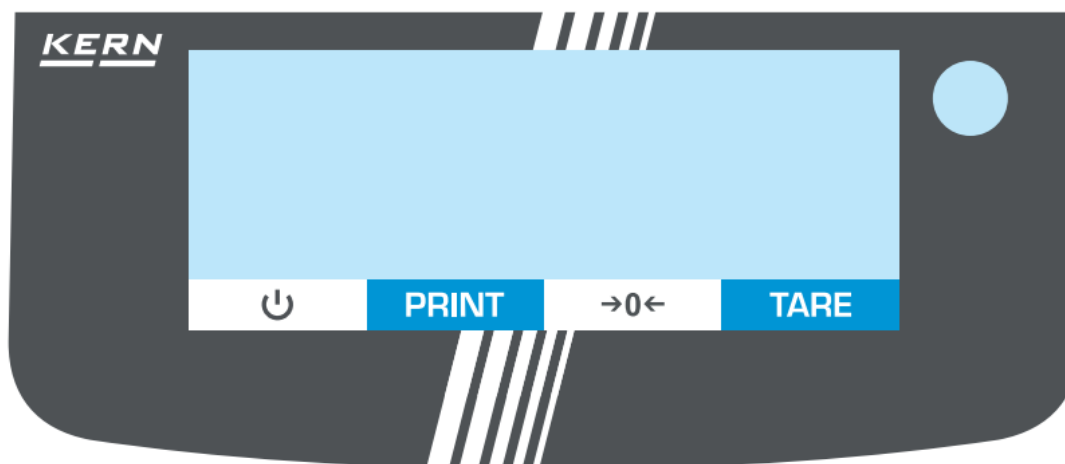

Pos.	Designation
7	USB-C connection
8	RS232 / RS485 connection
9	Mains connection
10	Anti-theft device
11	Underfloor weighing system



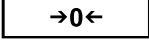

3.2 Operating elements



3.2.1 Keyboard overview

Button	Name	Function in operating mode
	ON	<ul style="list-style-type: none"> ➤ Switch on ➤ Stand-by: The time is displayed during stand-by. Press again to switch the scales back on
	PRINT	<ul style="list-style-type: none"> ➤ Output data
	ZERO	<ul style="list-style-type: none"> ➤ Zeros
	TARE	<ul style="list-style-type: none"> ➤ Taring







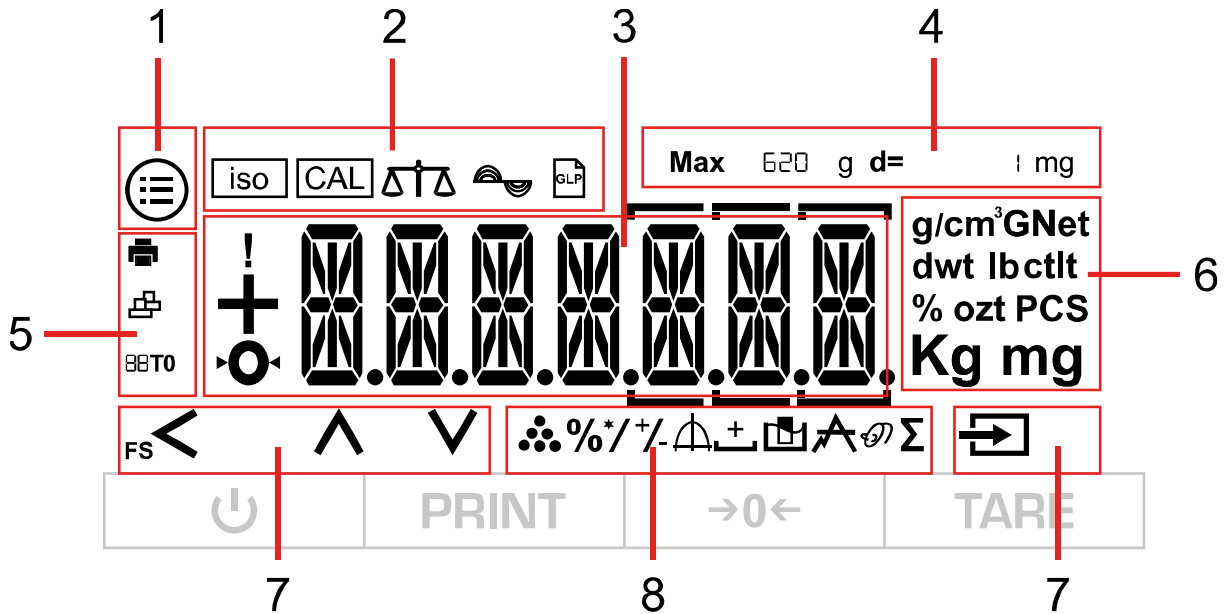

3.2.2 Numerical input

Button	Name
	<ul style="list-style-type: none"> • Increase flashing digit (0 - 9) • Move decimal point
	<ul style="list-style-type: none"> • Decrease flashing digit (0 - 9) • Move decimal point
	<ul style="list-style-type: none"> • One digit back • Press the button repeatedly to exit the input window and cancel the numerical input
	<ul style="list-style-type: none"> • Select digit • Confirm entry. Press the button repeatedly for each digit. Wait until the numerical input window disappears.

3.2.3 Display overview



Pos.	Symbol	Description of the
1		Button: [Menu]
2		Button [iso]→ Starts isoCal
		Button: [CAL]→ Starts external calibration
		Application filter: Weighing or filling
		Environment button→ Switches between the environmental conditions: "very stable" (1.1.1.1), "stable" (1.1.1.2), "not stable" (1.1.1.3), "very unstable" (1.1.1.4), see Chap. 11.3.1
		Button: Print GLP protocol
3		Alarm: The scale is currently executing a command
		Sign of the weight value: positive or negative
		Indicator: Zero position
		Main display for weighing values or menu designations

Pos.	Symbol	Description of the
4	Max 620 g	Metrological data (depending on model): Maximum load
	d= 1 mg	Metrological data (depending on model): Readability
5		Indicator: Printer connected
		Indicator: Computer connected
	88T0	Additional display (e.g. AUTO)
6	g/cm³GNet dwt lbctlt % ozt PCS Kg mg	<ul style="list-style-type: none"> Weighing unit display and button: Displays the current weighing unit and allows you to change it by pressing the button (for available weighing units, see Chap. 1) Stability indicator: Unit is only displayed if the value is stable
7		Navigation bar: Description see Chap. 11.1
8		Application indicator: Counting
	%	Application indicator: Percentage weighing
	* /	Application indicator: Calculation
	+ / -	Application indicator: Tolerance weighing
		Application indicator: Statistics function
		Application indicator: Net total
		Application indicator: Density determination
		Application indicator: Peak value function
		Application indicator: Dynamic weighing
	Σ	Application indicator: Totalling

4 Basic information (general)

4.1 Intended use

The scales you have purchased are used to determine the weight of goods to be weighed. It is intended for use as a "non-automatic scale", i.e. the sample is placed manually, carefully and centred on the weighing plate. Once a stable weight value has been reached, the weight value can be read off.

4.2 Improper use

- Our scales are non-automatic scales and are not intended for use in dynamic weighing processes. However, the scales can also be used for dynamic weighing processes after checking the individual area of application and, in particular, the accuracy requirements of the application.
- Do not leave a permanent load on the weighing plate. This can damage the measuring mechanism.
- Avoid shocks and overloading the scales above the specified maximum load (Max), minus any tare load already present. This could damage the scales.
- Never operate the scales in potentially explosive atmospheres. The standard version is not explosion-proof.
- The scale must not be modified in any way. This can lead to incorrect weighing results, safety-related defects and the destruction of the scale.
- The scale may only be used in accordance with the specifications described. Deviating areas of use/application must be approved in writing by KERN.

4.3 Guarantee

Warranty expires with

- Non-compliance with our specifications in the operating instructions
- Use outside the described applications
- Modifying or opening the device
- Mechanical damage and damage caused by media, liquids, natural wear and tear
- Improper set-up or electrical installation
- Overload of the measuring unit

4.4 Test equipment monitoring

As part of quality assurance, the metrological properties of the scales and any test weights must be checked at regular intervals. The responsible user must define a suitable interval as well as the type and scope of this check. Information regarding the monitoring of test equipment for balances and the test weights required for this is available on the KERN homepage (www.kern-sohn.com). In its accredited calibration laboratory, KERN can calibrate test weights and scales quickly and cost-effectively (traceability to the national standard).

5 Basic safety instructions

5.1 Observe the notes in the operating instructions



- ⇒ Read the operating instructions carefully before installation and commissioning, even if you already have experience with KERN scales.

5.2 Staff training

The appliance may only be operated and maintained by trained personnel.

6 Transport and storage

6.1 Control on takeover

Please check the packaging immediately upon receipt and the appliance for any visible external damage when unpacking.

6.2 Packaging/return transport



- ⇒ Keep all parts in the original packaging for any necessary return transport.
- ⇒ Only the original packaging is to be used for return transport.
- ⇒ Disconnect all connected cables and loose/movable parts before despatch.
- ⇒ Refit any transport locks provided.
- ⇒ Secure all parts, e.g. glass draft shield, weighing plate, power supply unit, etc. against slipping and damage.

7 Unpacking, installation and commissioning

7.1 Installation site, place of use

The scales are designed to achieve reliable weighing results under normal operating conditions.

You can work accurately and quickly if you choose the right location for your scales.

Observe the following at the installation site:

- Place the scales on a stable, level surface.
- Avoid extreme heat and temperature fluctuations, e.g. by placing the appliance next to a radiator or in direct sunlight.
- Protect the scales from direct draughts through open windows and doors.
- Avoid vibrations during weighing.
- Protect the scales from high humidity, vapours and dust.
- Do not expose the appliance to high humidity for long periods of time. Unauthorised condensation (condensation of humidity on the appliance) can occur if a cold appliance is brought into a much warmer environment. In this case, acclimatise the appliance disconnected from the mains for approx. 2 hours at room temperature.
- Avoid static charging of items to be weighed and weighing containers.
- Do not operate in potentially explosive atmospheres or in areas at risk of explosion due to gases, vapours, mists or dusts!
- Chemicals (e.g. liquids or gases) that could attack and damage the inside or outside of the scales must be kept away.
- If electromagnetic fields or static charges occur (e.g. when weighing / counting plastic parts) or if the power supply is unstable, large display deviations (incorrect weighing results and damage to the scales) are possible. The location must then be changed or the source of interference eliminated.

7.2 Unpacking and checking

Remove the appliance and accessories from the packaging, remove the packaging material and set up at the designated workstation. Check that all parts included in the scope of delivery are present and undamaged.

Scope of delivery / standard accessories:

- Scales
- Hook for underfloor weighing
- Weighing plate
- Individual weighing pan supports (models with draft shield)
- 4 individual weighing pan supports (models without draft shield)
- Plug-in power supply
- Operating instructions

7.3 Assembly, installation and levelling



The correct location makes a decisive contribution to the accuracy of the weighing results of high-resolution analytical balances (see section 7.1)

Devices with wind protection:

- ⇒ Attach the shield ring, weighing plate support and weighing plate in the correct order.

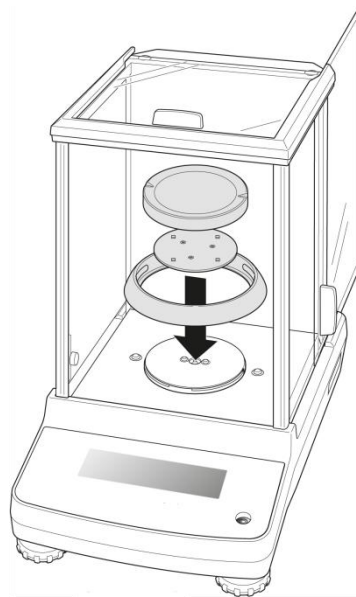

- ⇒ Level the scale with the foot screws until the air bubble in the spirit level is in the prescribed circle.

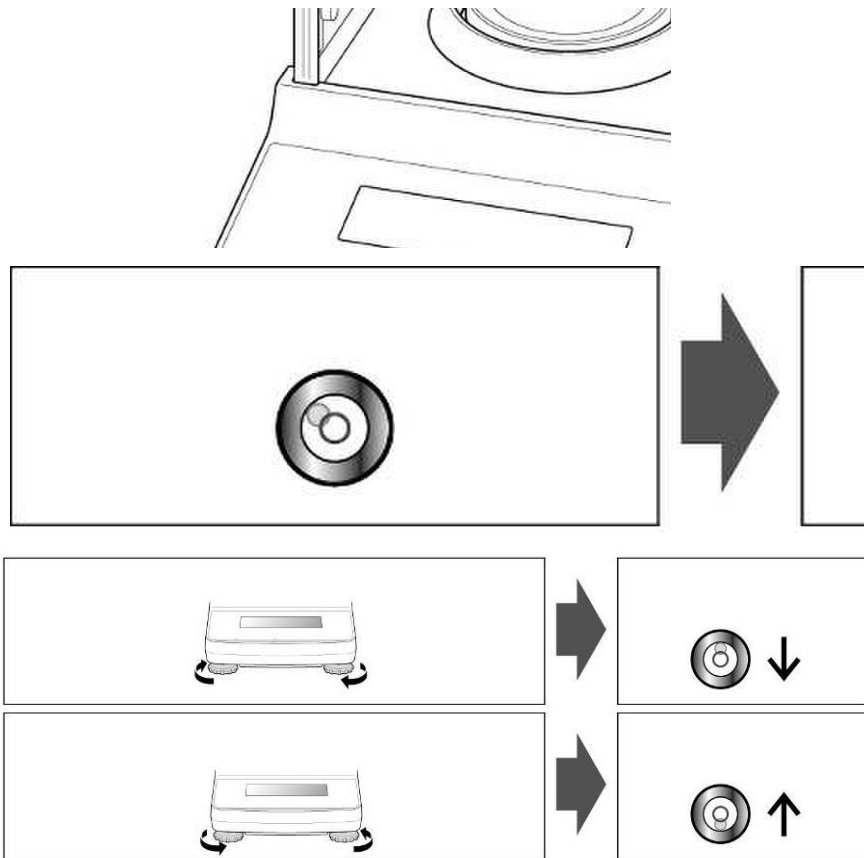

⇒ Check levelling regularly

Devices without wind protection:

- ⇒ Insert the weighing plate support (A) into the holes provided.
- ⇒ Place the weighing plate (B) in position.

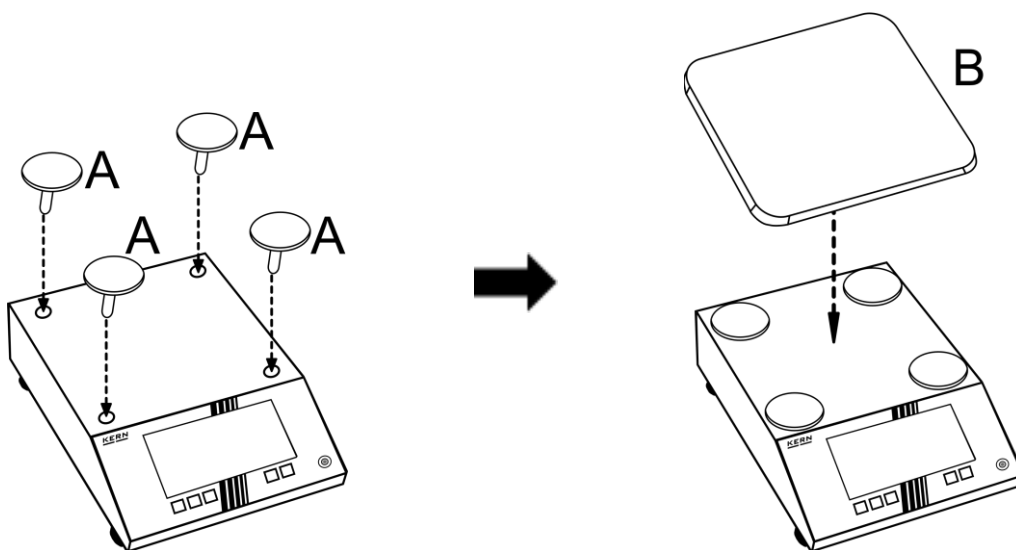

⇒ Make sure that the scales are level.

- ⇒ Level the scales with the foot screws (1) until the air bubble in the spirit level is in the prescribed circle (2).

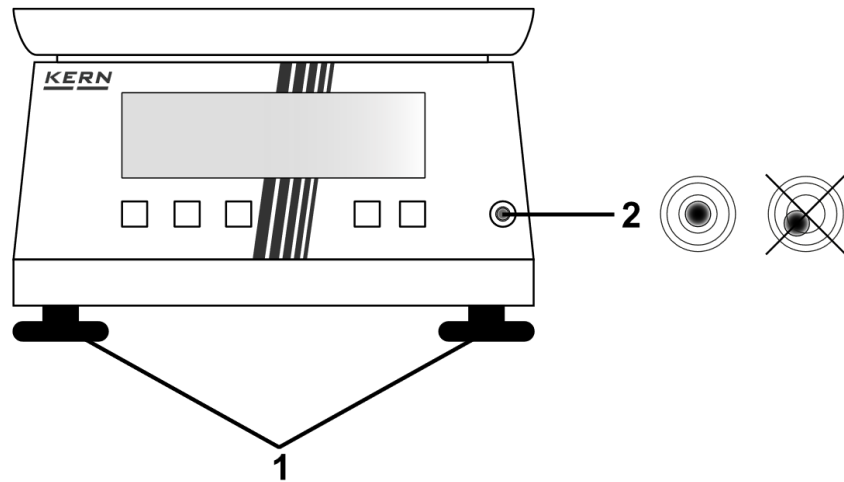

7.4 Mains connection



Select the country-specific mains plug and plug it into the power supply unit.



Check that the voltage input of the scale is set correctly. The scale may only be connected to the mains if the information on the scale (sticker) and the local mains voltage are identical.

Only use original KERN power supply units. The use of other makes requires the consent of KERN.



Important:

- Check the mains cable for damage before commissioning.
- Ensure that the power supply unit does not come into contact with liquids.
- The mains plug must be accessible at all times.

7.5 Connection of peripheral devices

Before connecting or disconnecting additional devices (printer, PC) to the data interface, the scale must be disconnected from the mains.

Only use accessories and peripherals from KERN with your balance, these are optimally matched to your balance.

7.6 Initial commissioning

In order to obtain accurate weighing results with electronic scales, the scales must have reached their operating temperature (see warm-up time, section 1). The scale must be connected to the power supply (mains connection, rechargeable battery or battery) for this warm-up time.

The accuracy of the scale depends on the local gravitational acceleration.

It is essential to follow the instructions in the Adjustment chapter.

8 Adjustment

As the value of the acceleration due to gravity is not the same at every location on earth, each scale must be adjusted to the prevailing acceleration due to gravity at the installation site in accordance with the underlying physical weighing principle (only if the scale has not already been adjusted to the installation site at the factory). This adjustment process must be carried out when the scale is first put into operation, after each change of location and in the event of fluctuations in the ambient temperature. In order to obtain accurate measured values, it is also advisable to periodically adjust the scale during weighing operation.



Carry out adjustment as close as possible to the maximum load of the scale (for recommended adjustment weight, see chapter 1). However, adjustment is also possible with weights of other nominal values or tolerance classes, but this is not optimal from a metrological point of view. The accuracy of the calibration weight must correspond approximately to the readability **[d]** of the scale, or slightly better. Information on test weights can be found on the Internet at: <http://www.kern-sohn.com>

- Ensure stable ambient conditions. A warm-up time (see section 1) is required for stabilisation.
- Ensure that there are no objects on the weighing plate.
- Avoid vibrations and air currents.
- Only carry out adjustment with the standard weighing plate in place.
- If an optional printer is connected and the GLP function is activated (DATAOUT.→ PRNTPAR.→ GLP → CAL -ADJ), the calibration report is output.

8.1 External adjustment



- The adjustment can be cancelled with [<]
- The following error message appears in the event of an adjustment error: <CAL/ERR>

Activate external adjustment in the menu:

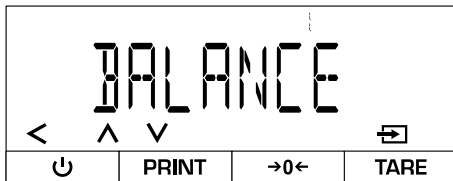

- ⇒ Open the following menu:
<SETUP> → <BALANCE>

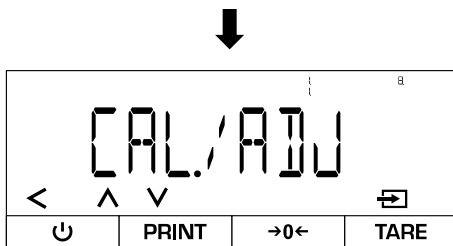

- ⇒ <CAL/ADJ> open

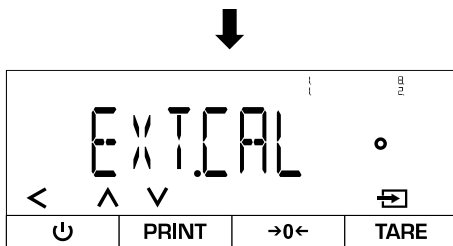

- ⇒ Select <EXTCAL>
- ⇒ Exit menu

Perform external adjustment:

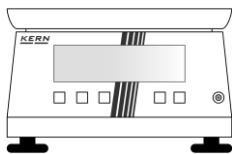

- ⇒ Unload the scales
- ⇒ Press [ZERO]

CAL

- ⇒ Press [CAL].

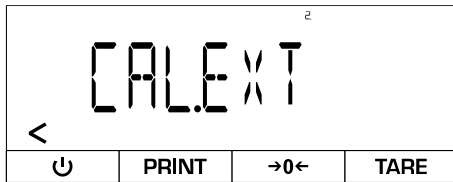

- ⇒ <CALEXT> is displayed
- ⇒ Required calibration weight in grams is displayed and starts flashing

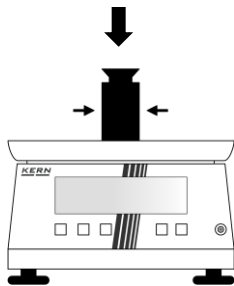
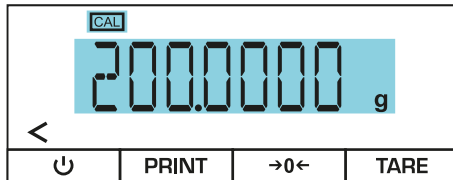

- ⇒ Place the calibration weight in the centre of the weighing plate
- ⇒ The calibration weight display stops flashing
- ⇒ Scale performs the external adjustment

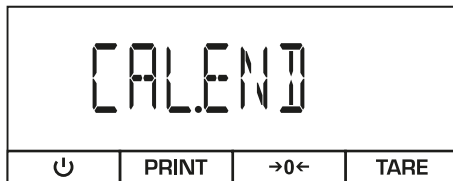
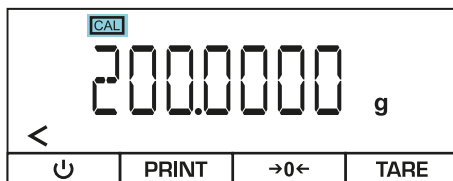

- ⇒ <CALEND> is displayed

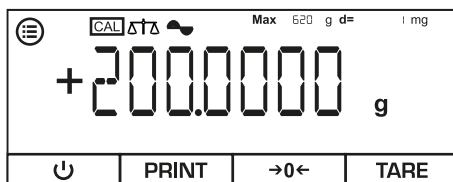

- ⇒ Scale switches back to weighing mode
- ⇒ Remove the calibration weight

8.2 External adjustment with user-defined adjustment weight



- The adjustment can be cancelled with [**<**]
- The following error message appears in the event of an adjustment error: **<CAL/ERR>**

Enter user-defined calibration weight:

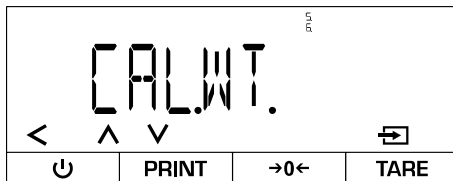

- ⇒ Open the following menu:
<INPUT> → <CAL.WT>

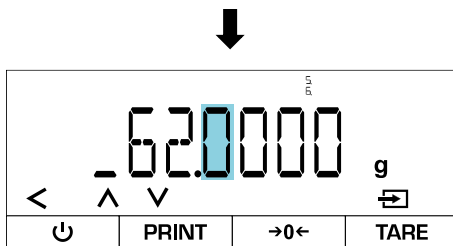

- ⇒ Enter the weight value of the external calibration weight (for numerical input, see Chap. 3.2.2)

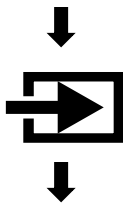

- ⇒ Confirm input

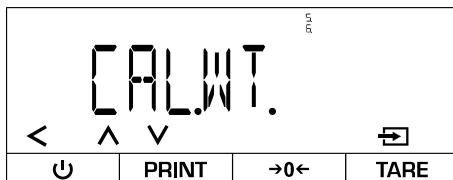

- ⇒ Scales return to the menu

Activate external adjustment with user-defined weight in the menu:

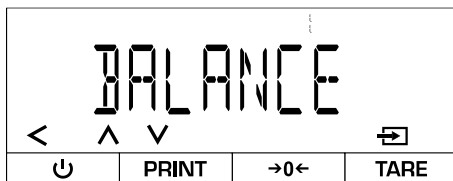

- ⇒ Open the following menu:
<SETUP> → <BALANCE>

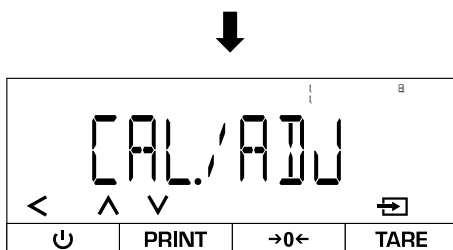

- ⇒ **<CAL./ADJ>** open

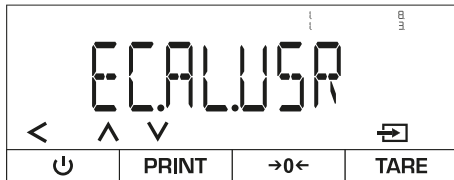

- ⇒ Select <E.CALUSR.>
- ⇒ Exit menu

Perform external adjustment:

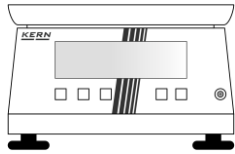

- ⇒ Unload the scales
- ⇒ Press [ZERO]

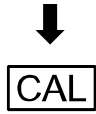

- ⇒ Press [CAL].

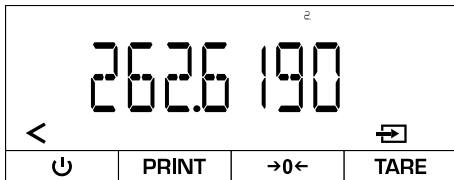

- ⇒ Required calibration weight in grams is displayed
- ⇒ Confirm

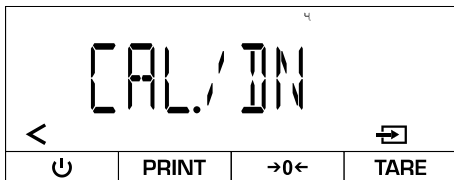
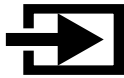

- ⇒ <CAL./IN> appears on the display

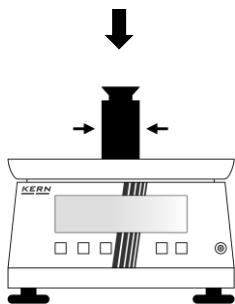

- ⇒ Place the calibration weight in the centre of the weighing plate

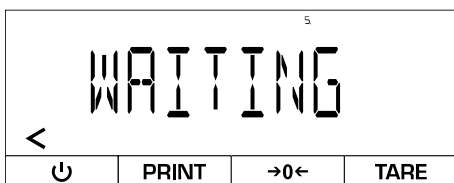

- ⇒ Scale performs the external adjustment

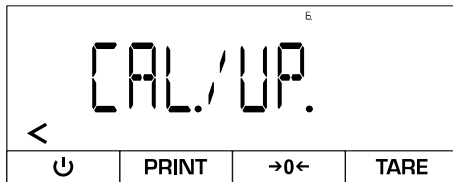

⇒ <CAL./UP.> appears on the display

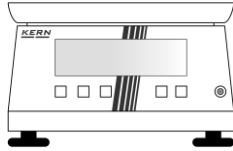

⇒ Remove the calibration weight from the weighing plate

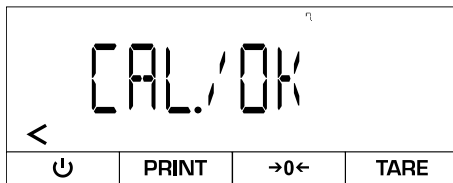

⇒ <CAL./OK> appears on the display

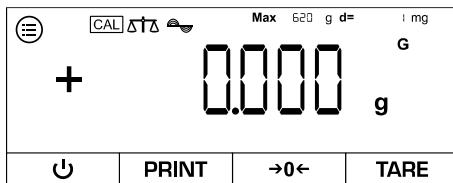

⇒ The scale switches to weighing mode

8.3 Internal adjustment



Internal adjustment is only available for the following series: TPDT-A

Activate internal adjustment in the menu:

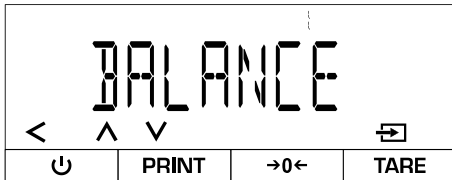

- ⇒ Open the following menu:
<SETUP> → <BALANCE>

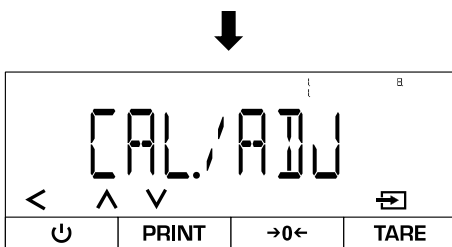

- ⇒ <CAL/ADJ> open

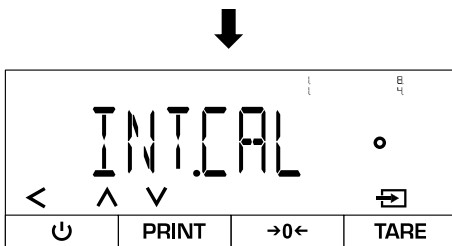

- ⇒ Select <INT.CAL>

Perform internal adjustment:

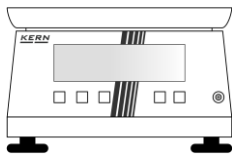

- ⇒ Unload the scales
- ⇒ Press [ZERO]



- ⇒ Press [iso]

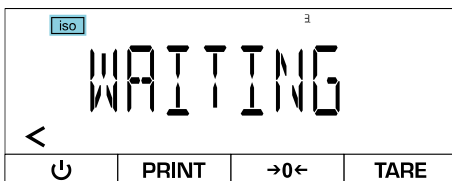

- ⇒ The internal adjustment is carried out
- ⇒ During adjustment, [iso] flashes

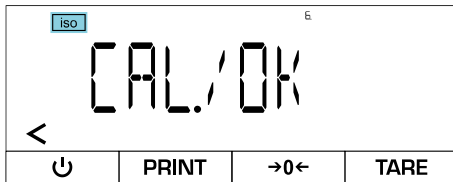

⇒ When the adjustment is complete, <CAL./OK> appears on the display

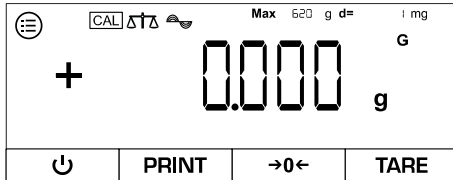

⇒ The scale switches to weighing mode

8.4 Automatic internal calibration (isoCAL)

The isoCAL function causes the scale to automatically carry out an internal calibration based on the ambient temperature and the running time.



The isoCAL function is always active for the following series and cannot be deactivated: TADT-A

Activate isoCAL in the menu:

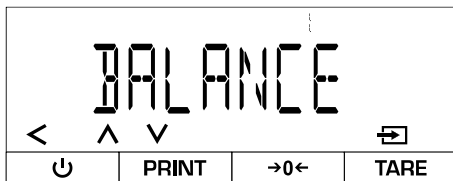

⇒ Open the following menu: <SETUP>→ <BALANCE>

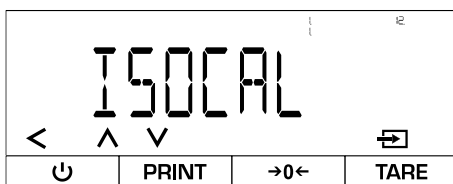

⇒ <ISOCAL> open

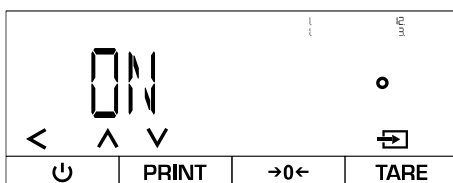

⇒ Select the desired setting

- | | |
|------|---|
| OFF | isoCAL deactivated |
| NOTE | Manual start of internal adjustment (note in the display) |
| ON | Automatic execution of the internal adjustment if this is required (depending on <CAL.TEMP> and <CAL.TIME>) |

⇒ Exit menu

Variante A - Manual start of internal adjustment when prompted:

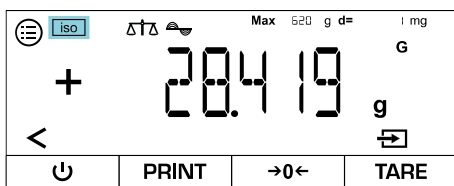

⇒ [iso] flashes

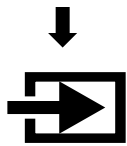

⇒ Confirm

...

⇒ Internal adjustment is carried out

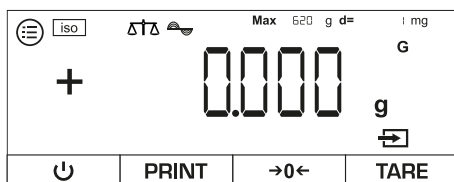

⇒ The scale switches to weighing mode

Variante B - Automatic start of internal adjustment:

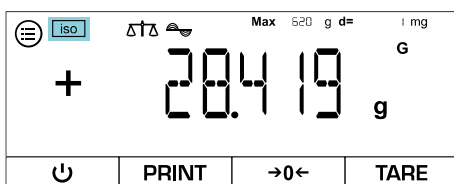

⇒ [iso] flashes

...

⇒ Internal adjustment is carried out automatically

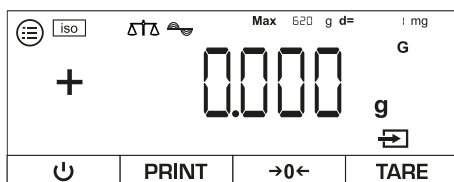

⇒ The scale switches to weighing mode

9 Basic operation

9.1 General instructions for operating with draft shield

Ensure that the scale doors are closed during weighing to obtain accurate weighing results.

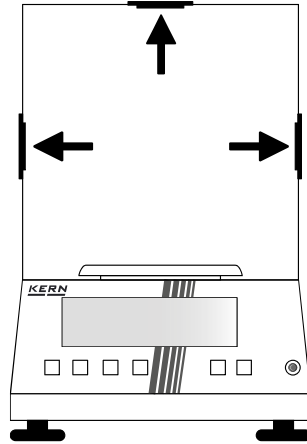

9.2 Switch on



⇒ Press [ON]

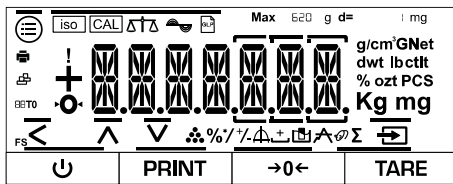

- ⇒ The display of the scales switches on
- ⇒ The scales carry out a self-test
- ⇒ The scale displays the model number

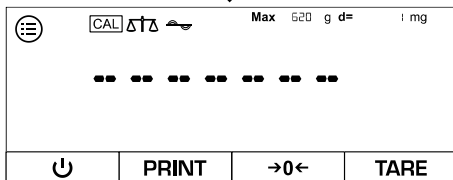

- ⇒ The scale performs an internal calibration (TPDT-A only)

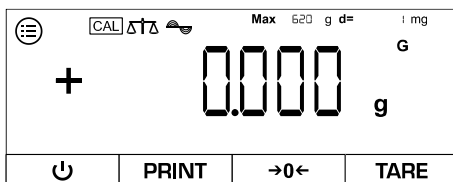

- ⇒ The scale switches to weighing mode
- ⇒ The scales are now ready for use

9.3 Standby mode



To switch off the scale completely, it must be disconnected from the mains. However, this is not recommended if the scale is in regular use due to the warm-up time.

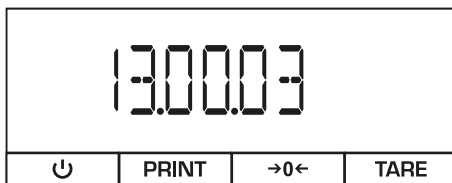

⇒ Press [ON] when the scales are switched on

⇒ The scales switch to standby mode and display the set time

9.4 Zeros

To achieve optimum weighing results, zero the scales before weighing.

Zeroing is only possible in the range $\pm 2\%$ max.

For values greater than $\pm 2\%$ max. the error message <PRESS--T> appears. This means that the scale is loaded and must be tared.

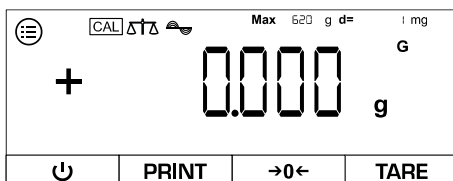
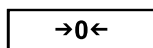
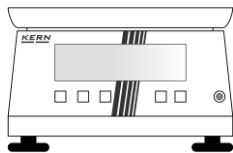

⇒ Unload the scales

⇒ Press [ZERO]

⇒ The scale performs a zero setting

9.5 Taring

The tare weight of any weighing container can be tared off at the touch of a button so that the net weight of the weighed goods is displayed for subsequent weighings.

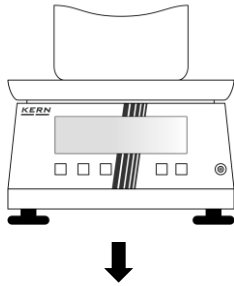

⇒ Place the container on the weighing plate

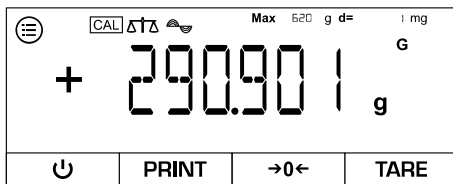

⇒ The weight of the container is displayed



⇒ Press [TARE]

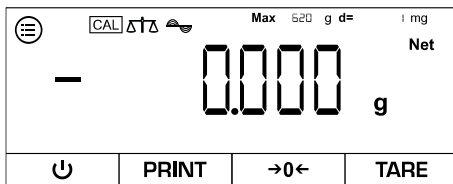

⇒ The net display appears on the display

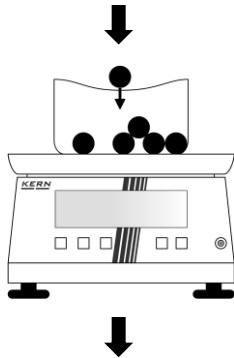

⇒ Weighing goods

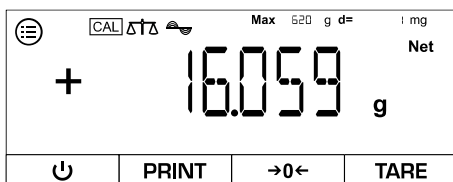

⇒ The net weight is displayed



- When the scales are unloaded, the stored tare value is displayed with a negative sign.
- To delete the stored tare value, release the load on the weighing plate and press the **TARE button** or **ZERO button**.
- The taring process can be repeated any number of times, for example when weighing in several components to form a mixture (additional weighing). The limit is reached when the taring range is fully utilised.

10 Applications

10.1 Selection of a weighing application

Call up the menu and select the weighing application:

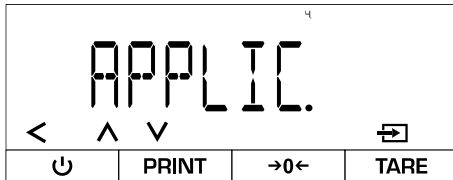

⇒ Open menu

⇒ Select <APPLIC>

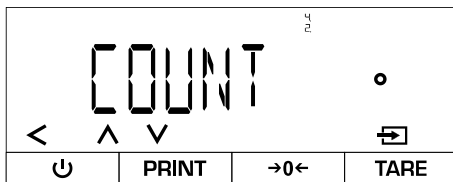

⇒ Select the desired application (for an overview of the applications, see Chap. 11.2)

⇒ The selected application is marked with a circle

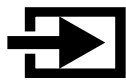

Make further settings for a weighing application:

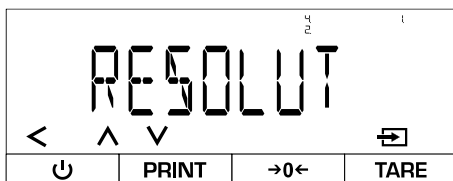
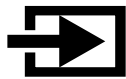

⇒ Pressing the confirmation button again takes you to the settings level of the selected application

⇒ Make settings



Exit menu:





⇒ Exit the menu using the navigation button [<] as soon as all the desired settings have been made

10.2 Simple weighing

10.2.1 Application menu

⇒ APPLIC → WEIGH

Parameters	Setting	Code	Description of the
UNIT	ON	4.1.1.1	Activates the button to switch between weighing units
g/cm ³ GNwt dwt lbctlt % ozt PCS Kg mg	OFF	4.1.1.2	Deactivates the button to switch between weighing units
APPFILT	ON	4.1.2.1	Activates the quick access button for the "Weigh" or "Fill" application filter
	OFF	4.1.2.2	Deactivates the quick access button for the "Weigh" or "Fill" application filter
AMBIENT	ON	4.1.3.1	Activates the button for quick access to the environmental conditions setting
	OFF	4.1.3.2	Deactivates the button for quick access to the environmental conditions setting

10.2.2 Carry out simple weighing

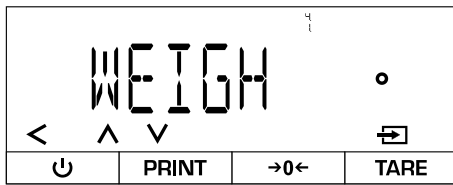

- ⇒ Open the following menu:
<APPLIC> → <WEIGH>
- ⇒ Select application
- ⇒ Exit menu

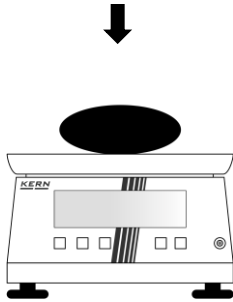

- ⇒ Zeroing or taring if necessary
- ⇒ Load the sample

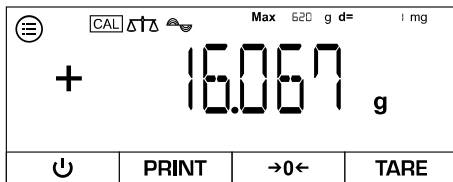

- ⇒ Read the weight value



Overload warning

Avoid overloading the appliance beyond the specified maximum load (Max), minus any existing tare load. This could damage the appliance. Exceeding the maximum load is indicated by the <HIGH> display. Unload the scale or reduce the preload.

10.2.3 Carry out underfloor weighing

CAUTION



Risk of breakage due to overloading of the hook

Falling loads can lead to injuries

- ⇒ Check that the scales are free of damage and in perfect working order before each use.
- ⇒ Never exceed the specified maximum load (max.) of the scale.
- ⇒ Make sure that there are no living creatures or objects under the load that could be damaged.

NOTE



- ⇒ After completion of underfloor weighing, the opening at the bottom of the scales must be closed again (dust protection).

Underfloor weighing can be used to weigh items that cannot be placed on the weighing pan due to their size or shape.

Carry out underfloor weighing:

1. Switch off the scales.
2. Turn the scales over.
3. Open the cover on the base of the scales.
4. Place the scales over an opening.
5. Screw in the hook completely.
6. Attach the load and carry out weighing.

10.2.4 Changing the weighing unit

Activate available weighing units for quick access in the menu:

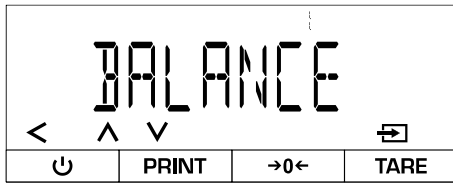

- ⇒ Open the following menu:
<SETUP> → <BALANCE>

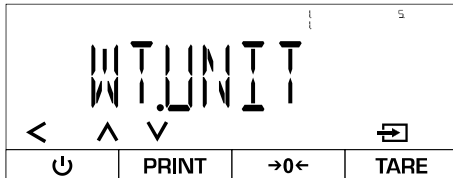

- ⇒ Open <WTUNIT>

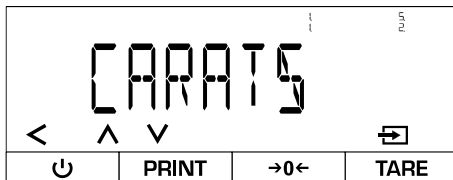

- ⇒ Select the desired weighing unit (refer to the technical data for available weighing units)

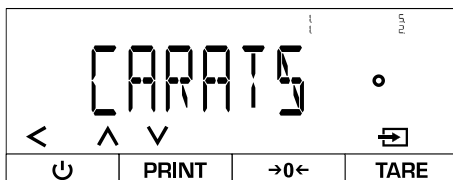

- ⇒ Selected weighing units are marked with a circle



...



- ⇒ Switch through and select further weighing units as described above

- ⇒ Exit the menu using the navigation button [←] as soon as all desired weighing units have been selected

Change the weighing unit during operation:

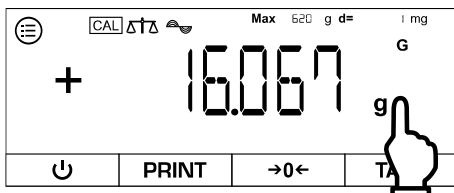

⇒ Touch the weighing unit field (quick access must be activated → see Chap. 10.2.1)

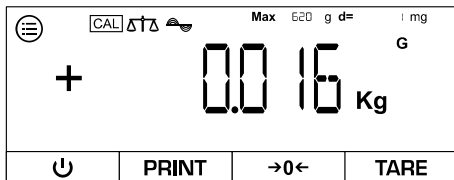

⇒ The display changes the weighing unit



To deactivate the quick access function, make the following setting:

APPLIC → WEIGH → UNIT → OFF

After this setting, the scale only displays the last active weighing unit.

10.3 Counting

The "Counting" application enables several parts to be counted on the weighing plate. The scale requires the average piece weight to determine the number of pieces. For this purpose, a defined number of parts is placed on the scale as a reference quantity. This number is used to calculate the average piece weight, which serves as the basis for the count. As a general rule, the higher the reference piece count, the greater the counting accuracy.

10.3.1 Application menu

⇒ APPLIC → COUNT

Parameters	Setting	Code	Description of the
RESOLUT	DISPACC	42.11	Counting resolution is the same as the display resolution
	10FOLD	42.12	Counting resolution is 10 times finer than the display resolution
	100FOLD	42.13	Counting resolution is 100 times finer than the display resolution

10.3.2 Carry out a count

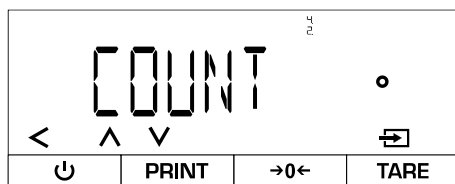

- ⇒ Open the following menu:
<APPLIC> → <COUNT>
- ⇒ Select application

Weigh reference quantity:

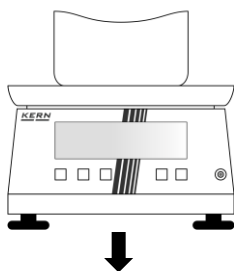

- ⇒ Zeros, if applicable
- ⇒ If necessary, place empty container on the weighing plate and tare

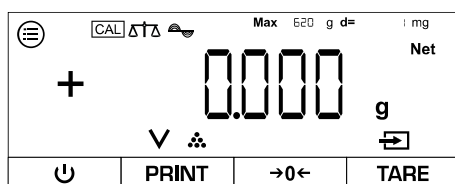

- ⇒ The scales are now in counting mode

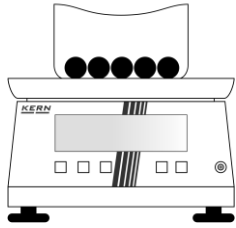

⇒ Place reference quantity



⇒ Press [v]

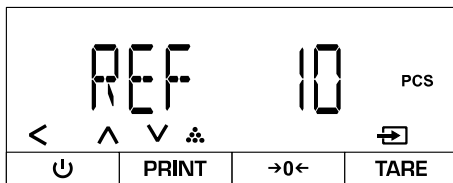

⇒ Select number of reference pieces

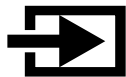

⇒ Current reference quantity is displayed

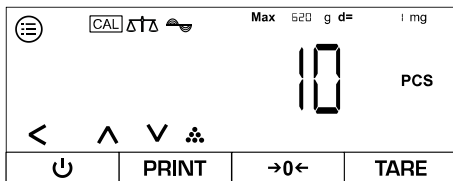

Weigh the total number of items:

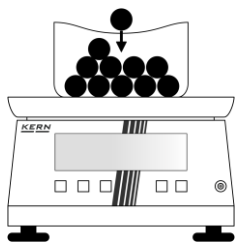

⇒ Add more pieces



⇒ Read off the total quantity

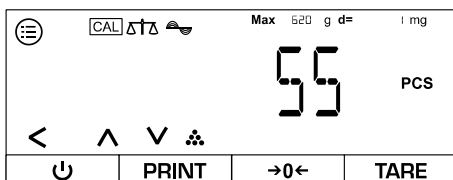

10.4 Percentage weighing

The "Percentage weighing" application allows you to determine the percentage of a sample in relation to a reference weight.

10.4.1 Application menu

⇒ APPLIC → PERCENT

Parameters	Setting	Code	Description of the
DECPLCS	NONE	43.11	Percentage value is displayed without decimal places
	1 DECPL	43.12	Percentage value is displayed with one decimal place
	2 DECPL	43.13	Percentage value is displayed with two decimal places
	3 DECPL	43.14	Percentage value is displayed with three decimal places

10.4.2 Perform percentage weighing

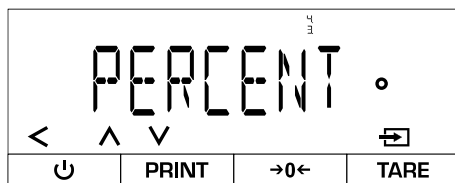

- ⇒ Open the following menu:
<APPLIC> → <PERCENT>
- ⇒ Select application
- ⇒ Exit menu



Weigh reference weight:

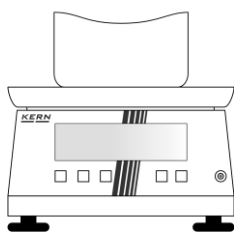

- ⇒ Zeros, if applicable
- ⇒ If necessary, place empty container on the weighing plate and tare

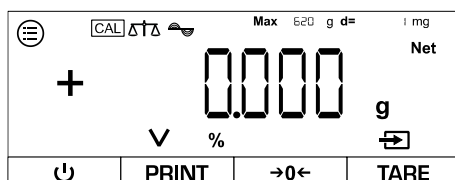

- ⇒ The scale is now in per cent mode



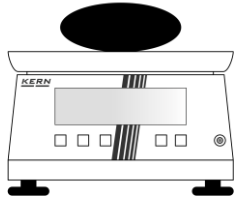

⇒ Apply reference weight



⇒ Press [v]

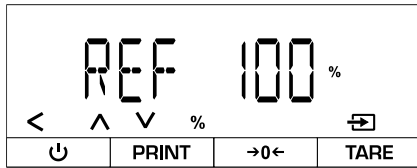

⇒ Select the percentage value of the reference weight

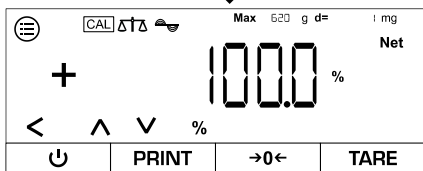
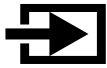

⇒ Current percentage value is displayed

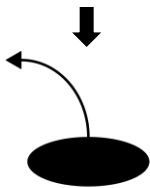

⇒ Remove reference weight

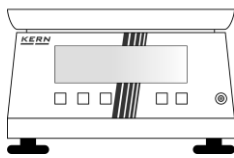

Determine the percentage value of another load:

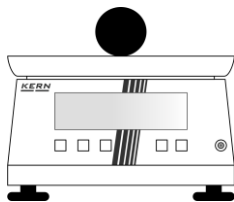

⇒ Apply a new load

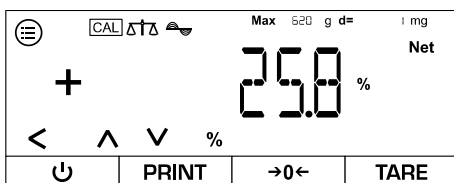

⇒ Percentage value of the load in relation to the reference weight is displayed

10.5 Net total

The "Net total" application enables the weighing of individual components to form a mixture.

10.5.1 Application menu

⇒ APPLIC → NET.TOT

Parameters	Setting	Code	Description of the
PRTCOMP	ON	44.11	Values of the individual components are output
	OFF	44.12	Values of the components are not output

10.5.2 Carry out total net weighing

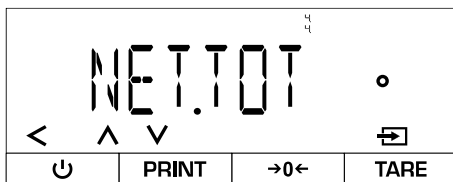

- ⇒ Open the following menu:
<APPLIC> → <NET.TOT>
- ⇒ Select application
- ⇒ Exit menu

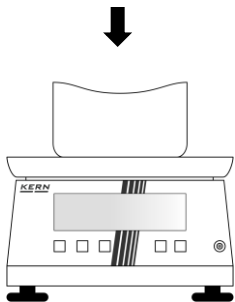

- ⇒ Zeros, if applicable
- ⇒ If necessary, place empty container on the weighing plate and tare

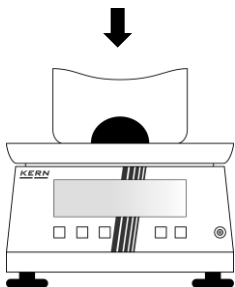

- ⇒ Weigh the first component

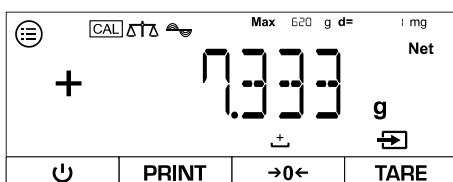

- ⇒ The scale displays the weight of the component
- ⇒ Confirm

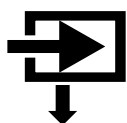

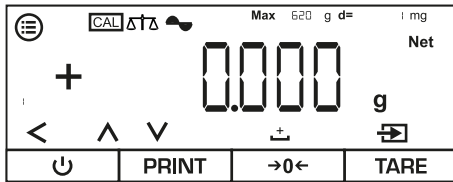

- ⇒ The scale stores the weight of the component (the number at the bottom left indicates the number of components weighed)

- ⇒ The scales tare automatically

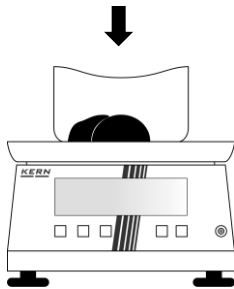

- ⇒ Weigh in the next component

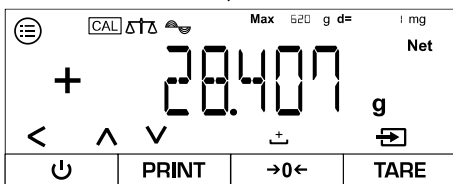

- ⇒ The scale displays the weight of the component

- ⇒ Confirm

- ⇒ The scale stores the weight of the component

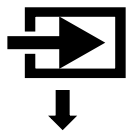

...

- ⇒ For other components, continue as described above



- Press [^] or [v] to switch between the display of the current number of weighed components, the total weight and the display of the current weight
- The current recipe can be cancelled with [<]
- If the scale is connected to a peripheral device (e.g. printer, computer), a log can be output.

10.6 Dynamic weighing

The "Dynamic weighing" application enables the weighing of unsteady loads (e.g. animals). As soon as the weight fluctuations are within a certain range, the scales can "freeze" and display the measurement result.

10.6.1 Application menu

⇒ APPLIC → ANIMWG

Parameters	Setting	Code	Description of the
ACTIVIT	CALM	45.11	Dynamic weighing: Load hardly moves
	ACTIV	45.12	Dynamic weighing: Load moves
	VACTIV	45.13	Dynamic weighing: Load moves strongly
START	MANUAL	45.2.1	Dynamic weighing must be activated manually on the start screen
	AUTO	45.2.2	Dynamic weighing is started automatically when an unsteady load is applied

10.6.2 Perform dynamic weighing

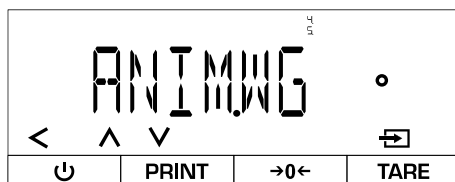

- ⇒ Open the following menu:
<APPLIC> → <ANIMWG>
- ⇒ Select application



Set the activity level of the sample:



- ⇒ Confirm

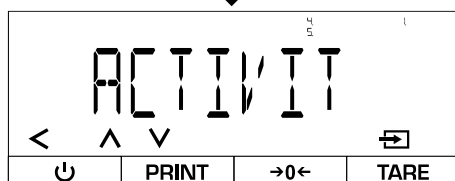

- ⇒ Select <ACTIVIT>
- ⇒ Select activity level (see Chap. 10.6.1)
- ⇒ Exit menu



Set the average number of measuring cycles:

The higher the set value, the more measurements are taken before a result is displayed. If the load is too unsteady, the measurements are stopped and restarted.

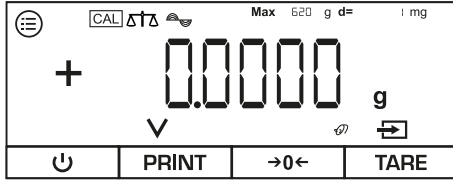

⇒ Press [v]

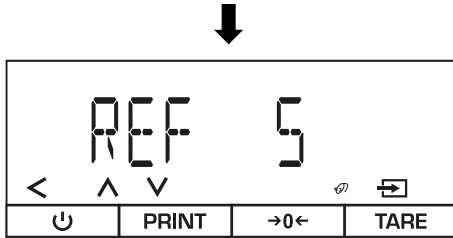

- ⇒ Select the desired number of measuring cycles
- ⇒ Scale switches back to weighing mode after confirmation

Perform dynamic weighing:

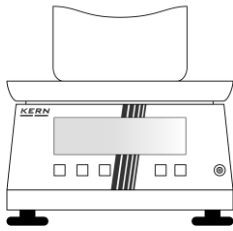

- ⇒ Zeros, if applicable
- ⇒ If necessary, place empty container on the weighing plate and tare

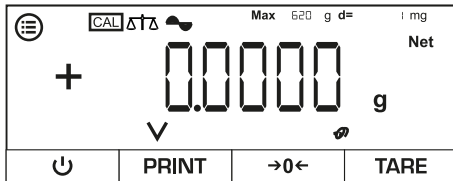

Variant A - Manual start (<START> → <MANUAL>):

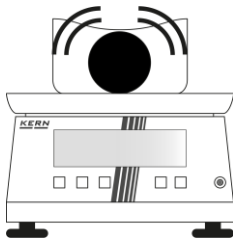

- ⇒ Place sample
- ⇒ Confirm



Variant B - Automatic start (<START>→<AUTO>):

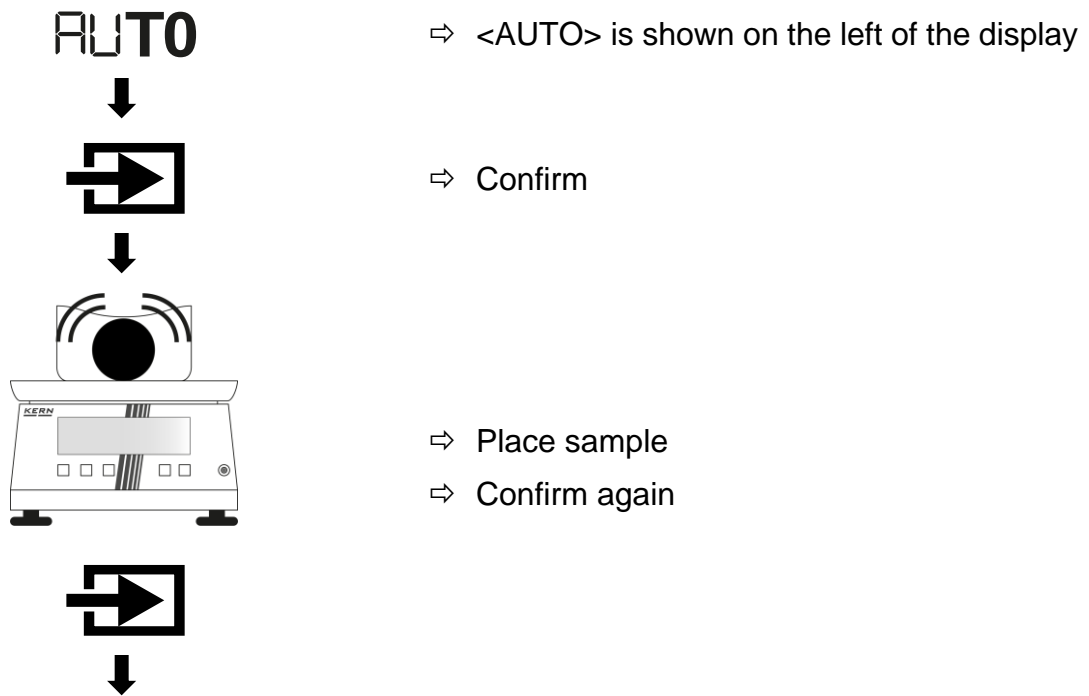

Read off the measurement result:

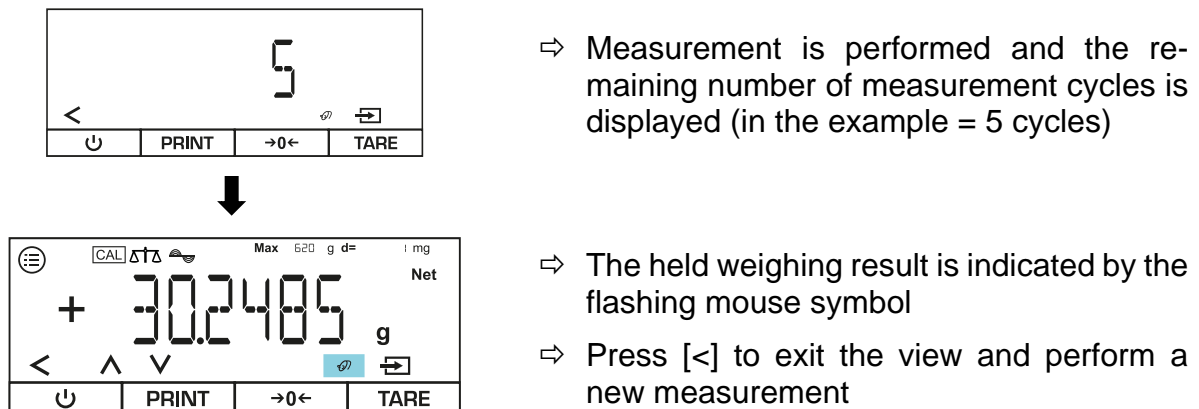

10.7 Calculation

The "Calculation" application allows you to calculate the weight by multiplication or division. This can be used to calculate the weight per unit area, for example.

10.7.1 Application smenu

⇒ APPLIC → CALC

Parameters	Setting	Code	Description of the
METHOD	MUL	46.11	Method: Multiplication
	DIV	46.12	Method: Division
DECPLCS	NONE	462.1	No decimal point
	1 DECPL	462.2	One decimal place
	2 DECPL	462.3	Two decimal places
	3 DECPL	462.4	Three decimal places

10.7.2 Perform calculation

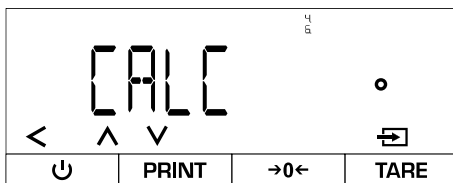

- ⇒ Open the following menu:
<APPLIC> → <CALC>
- ⇒ Select application

Select method:

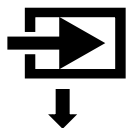

- ⇒ Confirm

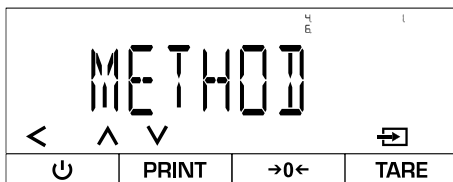

- ⇒ Select <METHOD>
- ⇒ Select method
- ⇒ If necessary, make further settings (see Chap. 10.7.1)
- ⇒ Exit menu

Enter factor or divisor:

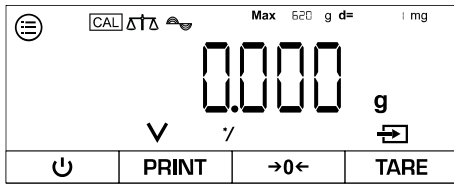

⇒ Press [v]

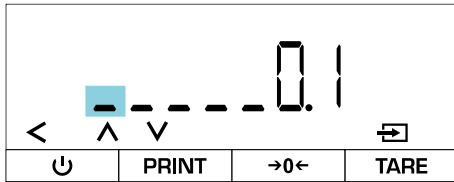

⇒ Enter value (for numerical input, see Chap. 3.2.2)



Perform calculation:

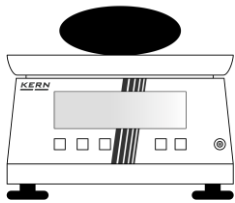

- ⇒ Zeroing or taring if necessary
- ⇒ Load the sample

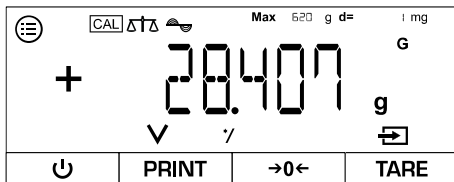

⇒ Weight value is displayed

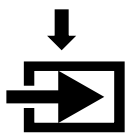

⇒ Confirm

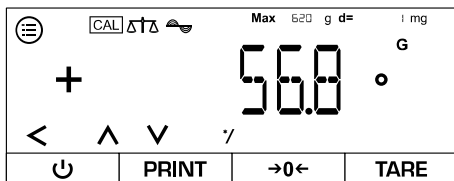

⇒ The result of the calculation is displayed



⇒ Exit the menu using the navigation button [<] as soon as all the desired settings have been made

10.8 Density determination

When determining the density of solids, the solid is first weighed in air and then in an auxiliary medium (e.g. distilled water or ethanol) whose density is known. The difference in weight results in the buoyancy, from which the software calculates the density. The specific density of the medium used must be known to the user.

The following steps are necessary to determine the density:

1. Prepare measuring equipment
2. Select weighing application for density determination
3. Select the substance type of the sample (e.g. liquid or solid)
4. Set the specific density of the auxiliary medium
5. Weigh sample without auxiliary medium
6. Weigh the sample in the auxiliary medium

10.8.1 Application smenu

⇒ APPLIC → DENSITY

Parameters	Setting	Code	Description of the
DECPLCS	NONE	47.11	No decimal point
	1DECPL	47.12	One decimal place
	2DECPL	47.13	Two decimal places
	3DECPL	47.14	Three decimal places
DECTYPE	LIQUID	47.2.1	Liquid sample
	SOLID	47.2.2	Fixed sample
	POWDER	47.2.3	Powdered sample
	POROUS	47.2.4	Porous sample

10.8.2 Prepare measuring equipment

NOTE



- ⇒ Once the underfloor weighing has been completed, the opening on the underside of the scale must be closed again to prevent foreign bodies from entering the scale (dust protection).
- ⇒ The immersion basket must not touch the container, as this can lead to incorrect results.

Set-up of the measuring equipment for density determination via underfloor weighing:

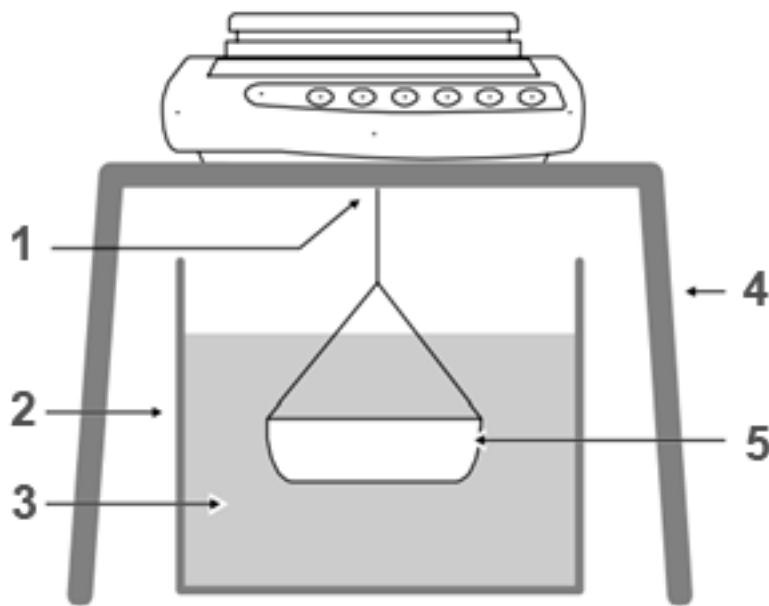

Pos.	Designation
1	Immersion basket on the device for underfloor weighing
2	Container for auxiliary medium
3	Auxiliary medium
4	Stable table for the scales
5	Dipping basket



A density determination set can be used as an alternative to underfloor weighing.

Information on density determination kits can be found at www.kern-sohn.com

10.8.3 Carry out density determination

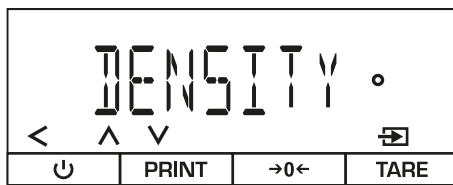

- ⇒ Open the following menu:
<APPLIC>→ <DENSITY>
- ⇒ Select application



Select the substance type of the sample:

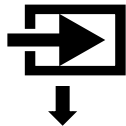

- ⇒ Confirm

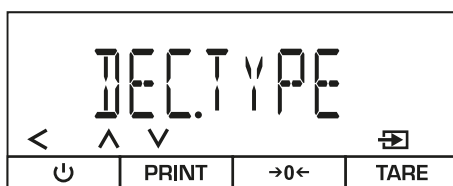

- ⇒ Select <DECTYPE>
- ⇒ Select fabric type
- ⇒ If necessary, make further settings (see Chap. 10.8.1)
- ⇒ Exit menu



Enter the value for the specific density of the auxiliary medium (value must be known):

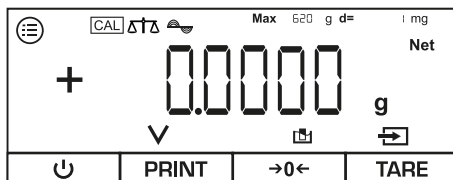

- ⇒ Press [v]

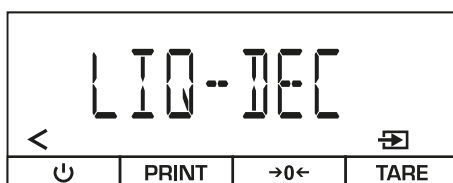

- ⇒ Confirm

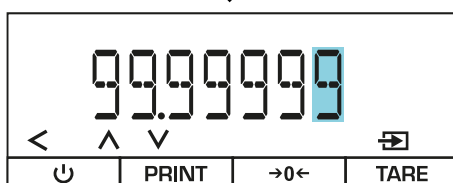
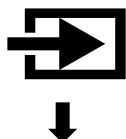

- ⇒ Enter the value for the specific density of the auxiliary medium (unit g / cm³; for numerical input, see Chap. 3.2.2)



Perform density determination (example for underfloor weighing):

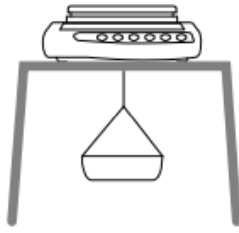

- ⇒ Measuring equipment according to chap. 0 Prepare
- ⇒ Tare the empty basket in the air (not in the auxiliary medium)

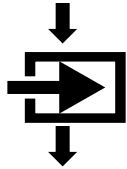

- ⇒ Confirm

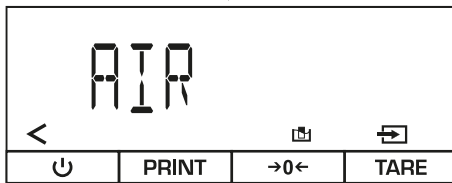

- ⇒ <AIR> is displayed

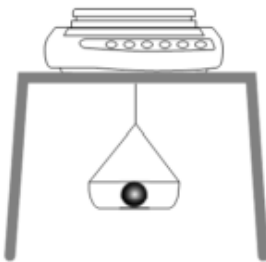

- ⇒ Place the sample in the dipping basket

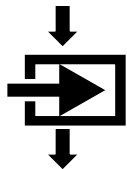

- ⇒ Confirm

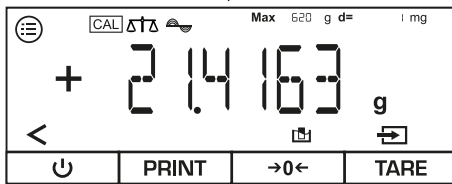

- ⇒ Weight value of the sample is displayed

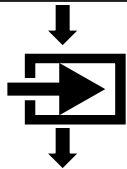

- ⇒ Confirm again

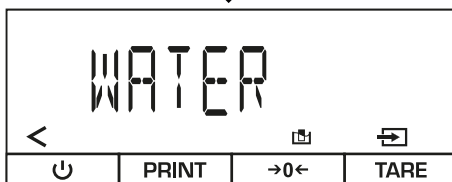

- ⇒ <WATER> is displayed

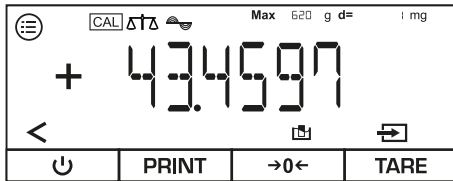
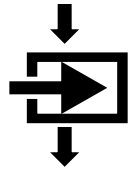
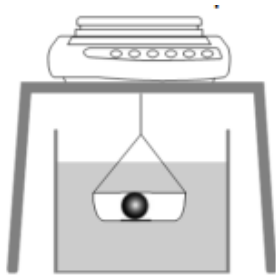

- ⇒ Place a container with water or other liquid under the scales
- ⇒ Place the sample in the dipping basket
- ⇒ Fully immerse the immersion basket with the sample in the water or liquid

⇒ Confirm

- ⇒ Density of the sample is displayed
- ⇒ Press [\leftarrow] to end the current density determination

10.9 Statistics function

The statistics function records up to 99 values and analyses them statistically. Subsequent values are saved and output:

- Highest value (maximum)
- Lowest value (minimum)
- Number of samples measured
- Standard deviation
- average

A printer must be connected and configured before the function can be used.

10.9.1 Application smenu

⇒ APPLIC → STATIST

Parameters	Setting	Code	Description of the
PRTCOMP	ON	48.11	Values of the individual components are output
	OFF	48.12	Values of the components are not output
TARSTAT	ON	44.11	Activates automatic taring after weighing in a component
	OFF	44.12	Deactivates automatic taring after weighing in a component

10.9.2 Create statistics

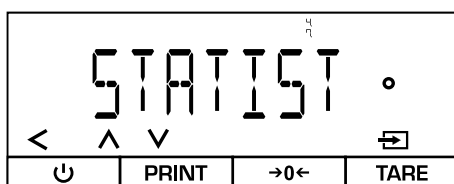

- ⇒ Open the following menu:
<APPLIC> → <STATIST>
- ⇒ Select application



Activate / deactivate automatic taring:

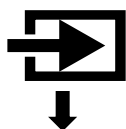

- ⇒ Confirm

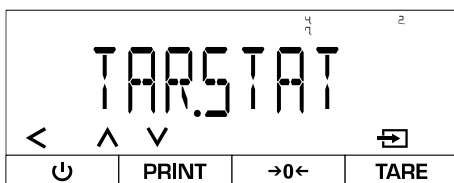

- ⇒ Select <TARSTAT>
- ⇒ Select tare mode (see chap. 10.9.1)
- ⇒ Exit menu



Variant A - Use statistics function with <TARSTAT>→<ON>:

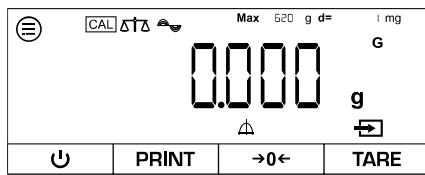

⇒ The scale is now in statistics mode

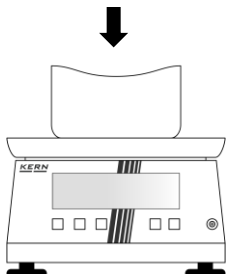

⇒ Zeros, if applicable

⇒ If necessary, place empty container on the weighing plate and tare

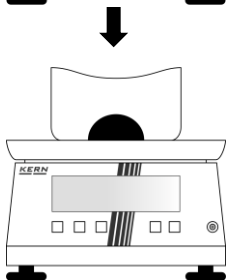

⇒ Apply weight

⇒ Confirm

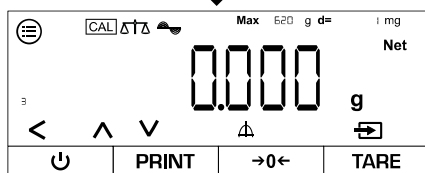

⇒ Weight value is saved (the number at the bottom left shows the number of weighings)

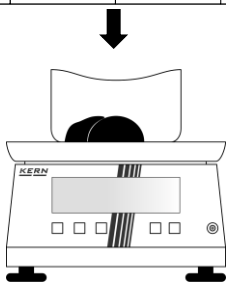

⇒ Weigh in the next weight

⇒ Confirm



...

⇒ For further weighings, continue as described above

Variant B - Use the statistics function with <TARSTAT>→<OFF>:

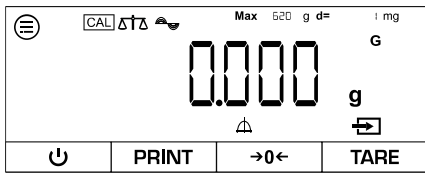

⇒ The scale is now in statistics mode

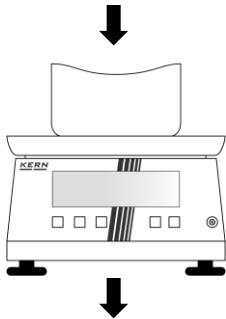

⇒ Zeros, if applicable

⇒ If necessary, place empty container on the weighing plate and tare

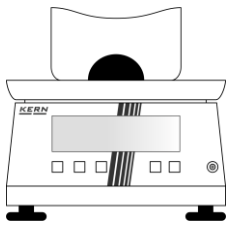

⇒ Apply weight

⇒ Confirm

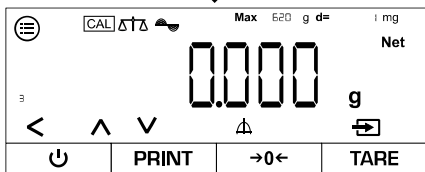

⇒ Weight value is saved (the number at the bottom left shows the number of weighings)

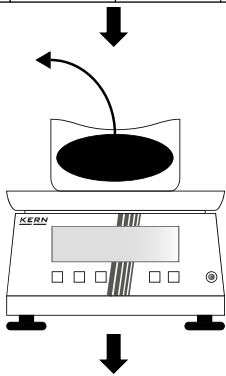

⇒ Remove or tare weight

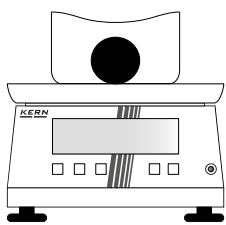

⇒ Weigh in the next weight

⇒ Confirm

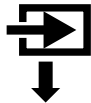

...

⇒ For further weighings, continue as described above



- Press [^] or [v] to switch between the display of the current weight, the display of the sample number and the average weight
- All values can be deleted with [<]
- If the scale is connected to a peripheral device (e.g. printer, computer), a log can be output.

10.10 Peak value function

The peak value function determines the maximum weight value (peak value) of a sample. To do this, the sample is removed from the weighing pan and the scale automatically determines the peak value within 5 seconds.

10.10.1 Application smenu

⇒ APPLIC → PEAKHL D

Parameters	Setting	Code	Description of the
APPLY	ATSTAB	49.11	Stable peak values are maintained
	W/OSTB	49.12	All peak values are maintained

10.10.2 Using the peak value function

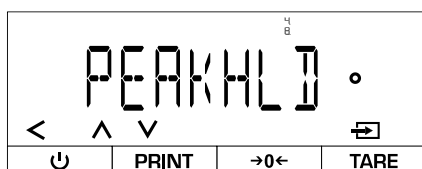

- ⇒ Open the following menu:
<APPLIC> → <PAKHL D>
- ⇒ Select application



Keep all values stable only (setting):



- ⇒ Confirm

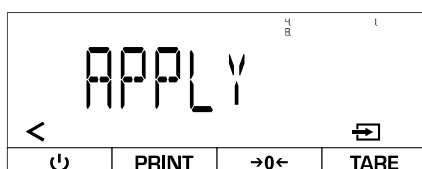

- ⇒ Select <APPLY>
- ⇒ Select setting (see chap. 10.10.1)
- ⇒ Exit menu

Measure peak values:

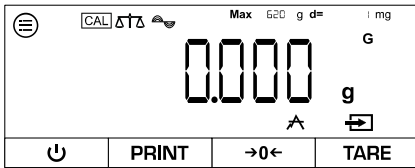

⇒ The scale is now in peak value mode

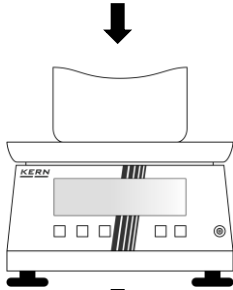

⇒ Zeroing or taring if necessary



⇒ Confirm to start the peak value measurement

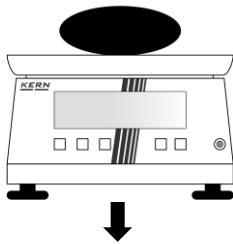

⇒ Apply weight

Display peak value:

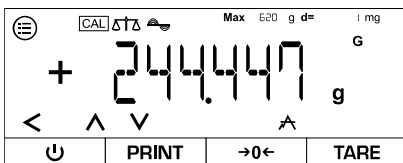

⇒ Current weight is displayed

⇒ Press [v]

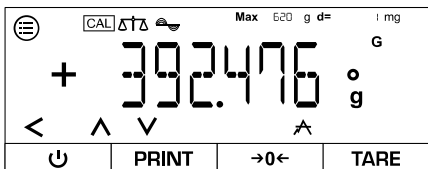

⇒ Peak value is displayed

⇒ Press [v] to exit the display again



- With [v] you can switch between the display of the current weight and the display of the current peak value
- The current peak value measurement can be ended with [<]
- If the scale is connected to a peripheral device (e.g. printer, computer), a log can be output.

10.11 Tolerance weighing

Setting a tolerance range allows you to quickly check whether a weight value is within certain limits.

10.11.1 Application smenu

⇒ APPLIC → CHECKWG

Parameters	Setting	Code	Description of the
INPUT	MANUAL	4.10.11	Limit values are entered numerically
	WGVALUE	4.10.12	Limit values are automatically adopted when the load is applied
AUTOPRT	OFF	4.10.2.1	Automatic printout deactivated
	OK ONLY	4.10.2.2	Only values that lie within the limits are printed
	NOT OK	4.10.2.3	Only values that lie outside the limits are printed
	ON	4.10.2.4	All values are printed

10.11.2 Carry out tolerance weighing

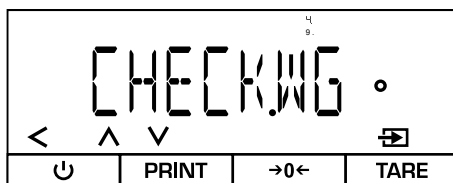

- ⇒ Open the following menu:
<APPLIC> → <CHECKWG>
- ⇒ Select application
- ⇒ Exit menu



Set limit values:

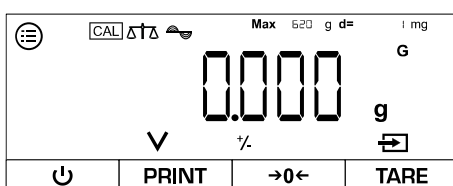

- ⇒ The scale is now in tolerance weighing mode
- ⇒ Press [v]

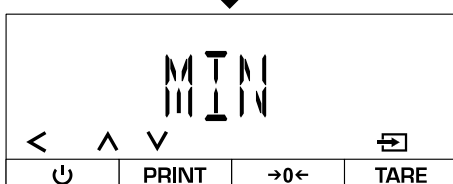

- ⇒ Select upper or lower limit value



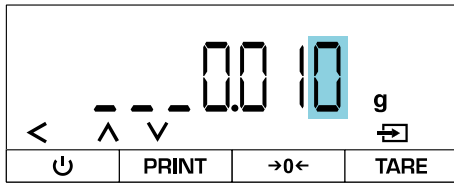

- ⇒ Enter limit value (for numerical input, see Chap. 3.2.2)
- ⇒ Then select and enter another limit value
- ⇒ Confirm
- ⇒ Exit menu



Carry out tolerance weighing:

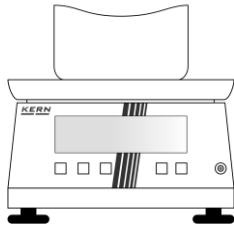

- ⇒ Zeroing or taring if necessary

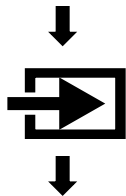

- ⇒ Confirm to start the peak value measurement

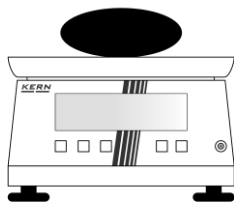

- ⇒ Load the sample
- ⇒ Weight value and tolerance display are shown

Display:

Weight value only	Within the tolerance
HH	Upper limit value exceeded
LL	Lower limit value undershot



- Press [^] or [v] to switch between the display of the stored limit values and the display of the current weight
- The current tolerance weighing can be ended with [<]
- If the scale is connected to a peripheral device (e.g. printer, computer), a log can be output.

10.12 Totalise

The totalise application allows you to weigh different samples and add up the weight values. This function can be used, for example, to weigh individual batches in order to determine the total stock.

10.12.1 Application smenu

⇒ APPLIC → TOTAL

Parameters	Setting	Code	Description of the
PRTCOMP	ON	41111	Values of the individual components are output
	OFF	41112	Values of the components are not output

10.12.2 Perform totalisation

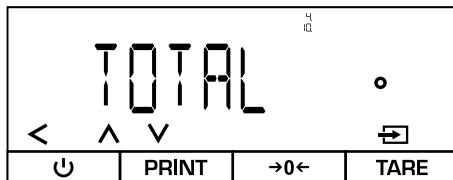

- ⇒ Open the following menu:
<APPLIC> → <TOTAL>
- ⇒ Select application

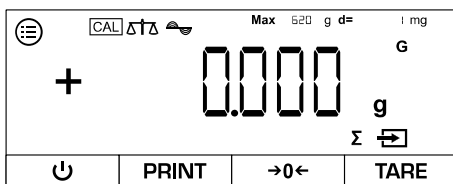

- ⇒ The scale is now in totalising mode

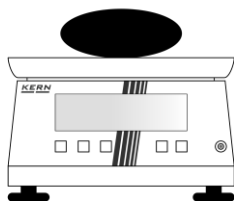

- ⇒ Zeroing or taring if necessary
- ⇒ Apply weight



- ⇒ Wait for a stable weight value
- ⇒ Confirm
- ⇒ Weight value is saved (the number at the bottom left shows the number of values in the totalising memory)

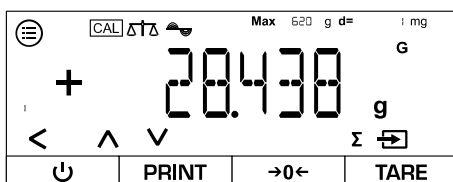

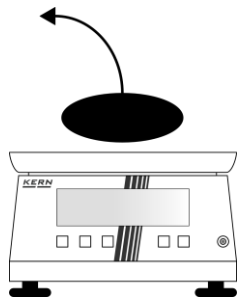

⇒ Remove weight

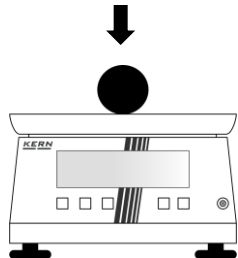

⇒ Apply a new weight

⇒ Confirm



...



⇒ Carry out further weighings if necessary



- Press [^] or [v] to switch between the display of the current number of values in the totaliser memory and the display of the current weight
- The current totalisation can be ended with [<]
- If the scale is connected to a peripheral device (e.g. printer, computer), a log can be output.

11 Menu

11.1 Navigation in the menu

Button	Name
	<ul style="list-style-type: none"> • Open menu
<div style="display: flex; justify-content: space-around; align-items: center;"> ^ v </div>	<ul style="list-style-type: none"> • Scroll forwards or backwards through menu items or settings
	<ul style="list-style-type: none"> • Return to previous menu or exit menu
	<ul style="list-style-type: none"> • Confirm current selection

11.2 Main menu

Level 1	Level 2	Code	Description of the
SETUP		1	Setup menu → see Chap. 11.3
	BALANCE	1.1	Basic scale settings → see Chap. 11.3.1
	GENSERV.	1.2	Factory settings → see Chap. 0
DEVICE		2	Device settings → see Chap. 11.4
	EXTRAS	2.1	User customisations → see Chap. 11.4.1
	RS-232	2.2	RS-232 settings → see Chap. 11.4.2
	RS-485	2.3	RS-485 settings → see Chap. 11.4.2
	USB	2.4	USB settings → see Chap. 11.4.2
DATAOUT.		3	Data output settings → see Chap. 0
	PRNTPAR	3.1	Print settings

Level 1	Level 2	Code	Description of the
APPLIC.		4.	Applications→ see Chap. 10
	WEIGH	4.1.	Simple weighing→ see Chap. 10.1
	COUNT	4.2.	Counting→ see Chap. 10.3
	PERCENT	4.3.	Percentage weighing→ see Chap. 10
	NET.TOT	4.4.	Net total→ see chap. 10.5
	ANIMWG	4.5.	Dynamic weighing→ see Chap. 10.6
	CALC	4.6.	Calculation→ see Chap. 10.7
	DENSITY	4.7.	Density determination→ see Chap. 10.8
	STATIST	4.8.	Statistics function→ see Chap. 10.9
	PEAKHLD	4.9.	Peak value function→ see Chap. 10.10
	CHECKWG	4.10.	Tolerance weighing→ see chap. 10.11
	TOTAL	4.11.	Totalise→ see Chap. 10.12
INPUT		5.	Input menu→ see Chap. 11.6
	DEV.ID	5.1.	Enter device identification number
	LOT.ID	5.2.	Lot identification number
	SPL.ID	5.3.	Sample identification number
	DATE	5.4.	Enter date (year-month-day→ YY-MM-DD)
	TIME	5.5.	Enter the time (hours-minutes-seconds→ HH-MM-SS)
	CAL.WT.	5.6.	Enter the user-defined calibration weight→ see Chap. 8.2
INFO		6.	Display device information
	VERSION	6.1.	Show software version
	SERNO.	6.2.	Display serial number
	MODEL	6.3.	Show model
	BACVER.	6.4.	Show BAC version
FACTORY		7.	Service menu→ locked (only for specialised personnel)

11.3 Setup menu

11.3.1 Basic scale settings

⇒ SETUP → BALANCE

Parameters	Setting	Code	Description of the
AMBIENT	VSTABLE	1.1.1	Ambient conditions "very stable"
	STABLE	1.1.2	Stable" ambient conditions
	UNSTABL	1.1.3	Ambient conditions "not stable"
	VUNSTABL	1.1.4	Ambient conditions "very unstable"
APPFILT	FINALRD	1.12.1	Readability for rapid load changes
	FILLING	1.12.2	Readability for bottling
STABRNG	VACC	1.13.1	Stability "very precise"
	ACC	1.13.2	Stability "exact"
	FAST	1.13.2	Stability "fast"
	VFAST	1.13.5	Stability "very fast"
AUTOZER	1-D	1.14.1	Automatic zero setting with deviation < 1 d
	2-D	1.14.2	Automatic zero setting with deviation < 2 d
	3-D	1.14.3	Automatic zero setting with deviation < 3 d
	4-D	1.14.4	Automatic zero setting with deviation < 4 d
	5-D	1.14.5	Automatic zero setting with deviation < 5 d
	OFF	1.14.6	Automatic zero setting with deviation < 1 d

Parameters	Setting	Code	Description of the
WTUNIT	GRAMS	1.15.1	Weighing unit: g
	CARATS	1.15.2	Weighing unit: ct
	MILLIGR	1.15.3	Weighing unit: mg
	OUNCES	1.15.4	Weighing unit: oz
	DWT	1.15.5	Weighing unit: dwt
	POUNDS	1.15.6	Weighing unit: lb
	KILOGR	1.15.7	Weighing unit: kg
	GRAINS	1.15.8	Weighing unit: gn
	OUNCES	1.15.9	Weighing unit: ozt
	TLT	1.15.10	Weighing unit: tlt
N	1.15.11	Weighing unit: N	
ONZ/T	ON	1.16.1	Zero setting activated when switching on
	OFF	1.16.2	Zero setting deactivated when switching on
DISP.DIG	MINUS	1.17.2	Last decimal place is not displayed
CAL/ADJ	CALOFF	1.18.1	Deactivate adjustment
	EXTCAL	1.18.2	[CAL] starts the external calibration with the preset calibration weight
	ECALUSR	1.18.3	[CAL] starts the external calibration with a user-defined calibration weight
	INTCAL	1.18.4	[iso] starts the internal adjustment
	INTADJ	1.18.5	[iso] starts the internal adjustment test

Parameters	Setting	Code	Description of the
CAL/SEQ	ADJUST	119.1	After calibration, the scale automatically switches to weighing mode
	CAL-ADJ	119.2	After adjustment, a manual confirmation must be carried out before the scale switches back to weighing mode
EXT.CAL	2000000	1110.1	Selecting the weight for external adjustment
	1000000	1110.2	
ISOCAL	OFF	1111.1	Automatic internal adjustment deactivated
	NOTE	1111.2	The following must be actively confirmed after adjustment
	ON	1111.3	Scale automatically switches back to the last active mode
CALTEMP	OFF	1112.1	Deactivate adjustment after temperature change
	15C	1112.2	Activate adjustment after temperature change: Scale requires an adjustment after the set temperature change
	2C	1112.3	
	3C	1112.4	
	4C	1112.5	
CALTIME	OFF	1113.1	Deactivate adjustment interval
	15H	1113.2	Activate adjustment interval: Scale requires adjustment after the set time
	2H	1113.3	
	3H	1113.4	
	4H	1113.5	

11.3.2 Factory settings

⇒ SETUP → GENSERV

Parameters	Setting	Code	Description of the
MENURES.	DEFAULT	12.11	Restore factory settings
	NO	12.12	Do not restore factory settings

11.4 Device settings

11.4.1 User customisations

⇒ DEVICE → EXTRAS

Parameters	Setting	Code	Description of the
MENU	EDITABL	2.1.11	Enable menu for settings
	RIDONLY	2.1.12	Lock menu for settings
SIGNAL	ON	2.12.1	Audible signal activated
	OFF	2.12.2	Acoustic signal deactivated

11.4.2 Interface settings

⇒ DEVICE → RS-232 or RS-485 or USB

Parameters	Setting	Code			Description of the
		RS-232	RS-485	USB	
BAUD	9600	22.11	23.11	24.11	Baud rate
	19200	22.12	23.12	24.12	
	38400	22.13	23.13	24.13	
	57600	22.14	23.14	24.14	
	115200	22.15	23.15	24.15	
	1200	22.16	23.16	24.16	
	2400	22.17	23.17	24.17	
	4800	22.18	23.18	24.18	

11.5 Data output settings

⇒ DATAOUT.→PRNTPAR.

Parameters	Setting	Code	Description of the
ACTIVAT	MANNO	3.1.1.1	Manual data output of all values
	MANAFTR	3.1.1.2	Manual data output of stable values
	INTERVA	3.1.1.3	Start and stop the continuous data output by pressing [PRINT].
	AUTOLOC	3.1.1.4	Automatic data output after every load change
FORMAT	22CHARS	3.1.2.1	Printout with 22 characters per line (16 characters for measured value, 6 characters for indicators)
	EXTRLIN	3.1.2.2	Printout of an additional line with date, time and weight value
	G/NET/T	3.1.2.3	Printout of gross, net and tare
GLP	OFF	3.1.3.1	GLP printout deactivated
	CAL-ADJ	3.1.3.2	GLP adjustment protocol
	ALWAYS	3.1.3.3	GLP always activated → All printouts contain a GLP header and footer
TIME	24H	3.1.4.1	Time in 24-hour format
	12H	3.1.4.2	Time in 12-hour format
DATE	DDMMYY	3.1.5.1	Date format: day-month-year
	MMDDYY	3.1.5.2	Date format: month-day-year
	YYMMDD	3.1.5.3	Date format: Year-Month-Day

11.6 Input menu

⇒ INPUT

Parameters	Setting		Code	Description of the
DEV.ID		Max. 14 characters (0-9, A-Z)	5.1.1	Enter device ID
LOT.ID	PRINT	ON	5.2.1.1	Output lot ID in the GLP protocol
		OFF	5.2.1.2	Do not output lot ID in GLP protocol
		Max. 14 characters (0-9, A-Z)		Enter lot ID (only if \angle PRINT \angle = \angle ON \angle ; for numerical input, see Chap. 3.2.2)
CONTENT				
SPL.ID	PRINT	ON	5.3.1.1	Output sample ID in the GLP protocol
		OFF	5.3.1.2	Do not output the sample ID in the GLP protocol
	START		5.3.2	Start number of the sample
	MODE	COUNTUP	5.3.3.1	Increment sample ID
		COUNTDN	5.3.3.2	Count down the sample ID
DATE			5.4.3	Enter date (year-month-day → YY-MM-DD)
TIME			5.5.1	Enter the time (hours-minutes-seconds → HH-MM-SS)
CAL.WT			5.6.1	Enter the user-defined calibration weight → see chapter 8.2

12 Communication with peripheral devices

Weighing data can be exchanged with connected peripheral devices via the interfaces. The output can be sent to a printer, PC or control displays.

12.1 RS232 / RS485 interface

The scale is equipped as standard with an RS232 / RS485 interface for connecting a peripheral device (e.g. printer or computer).

Connection: 9 pin d-subminiature socket

Baud rate: 600/1200/2400/4800/9600/19200/38400/57600/115200 wählbar

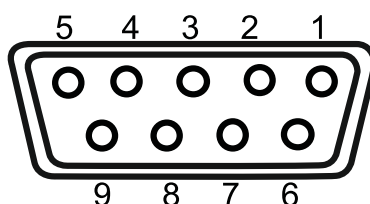

Pin assignment:

Pin no.	Signal
1	-
2	TxD
3	RxD
4	-
5	GND
6	485B
7	485A
8	-
9	-

12.2 USB-C connection

Communication: USB UTL

Compatible devices: DAT printer; Windows Direct

12.3 Connecting the printer to a scale

⇒ Switch off the scale and printer.

⇒

Connect the scale to the interface of a printer using a suitable cable .

Error-free operation is only guaranteed with the appropriate KERN interface cable (optional).

⇒ Switch on the scale and printer.



Communication parameters (baud rate, bits and parity) of scale and printer must match

13 Maintenance, servicing, disposal



Disconnect the appliance from the operating voltage before carrying out any maintenance, cleaning or repair work.

13.1 Cleaning

Do not use aggressive cleaning agents (solvents or similar), but only a cloth moistened with mild soapy water. Ensure that no liquid penetrates the appliance. Wipe with a dry, soft cloth.

Loose sample residues/powder can be carefully removed with a brush or hand Hoover.

Immediately remove any spilt weighing material.

- ⇒ Clean stainless steel parts with a soft cloth soaked in a cleaning agent suitable for stainless steel.
- ⇒ Do not use cleaning agents containing caustic soda, acetic, hydrochloric, sulphuric or citric acid on stainless steel parts.
- ⇒ Do not use metal brushes or cleaning sponges made of steel wool, as this causes surface corrosion.

13.2 Maintenance, servicing

- ⇒ The device may only be opened by trained service technicians authorised by KERN.
- ⇒ Disconnect from the mains before opening.

13.3 Waste disposal

The operator must dispose of the packaging and appliance in accordance with the applicable national or regional legislation at the place of use.

14 Small breakdown service

In the event of a fault in the programme sequence, the scale should be switched off briefly and disconnected from the mains. The weighing process must then be restarted from the beginning.

Malfunction

Possible cause

The scales cannot be switched on

- The power supply unit is not plugged in
- AC/DC defect

The weight indicator does not light up.

- The scales are not switched on.
- The connection to the mains is interrupted (mains cable not plugged in/defective).
- The mains voltage has failed.

The weight display changes continuously

- Draught/air movement
- Glass doors not closed
- Vibrations of the table/floor
- The weighing plate is in contact with foreign objects.
- Electromagnetic fields/static charging (choose a different installation location/switch off the interfering device if possible)

The weighing result is obviously incorrect

- The scale display is not set to zero
- The adjustment is no longer correct.
- The scales are not level.
- There are strong temperature fluctuations.
- The warm-up time was not observed.
- Electromagnetic fields / static charge (choose another installation location / if possible, switch off the interfering device)

15 Error messages

Error message	Explanation
HIGH	Overload
LOW	Underload
PRESS-0	Zero setting error
PRESS-T	Taring error
CAL/ERR	Adjustment error
DISERR	Settings error